



ice line

**MIGEL**



ice line

<http://www.migel-ice-line.com>  
e-mail: migel@migel-ice-line.com



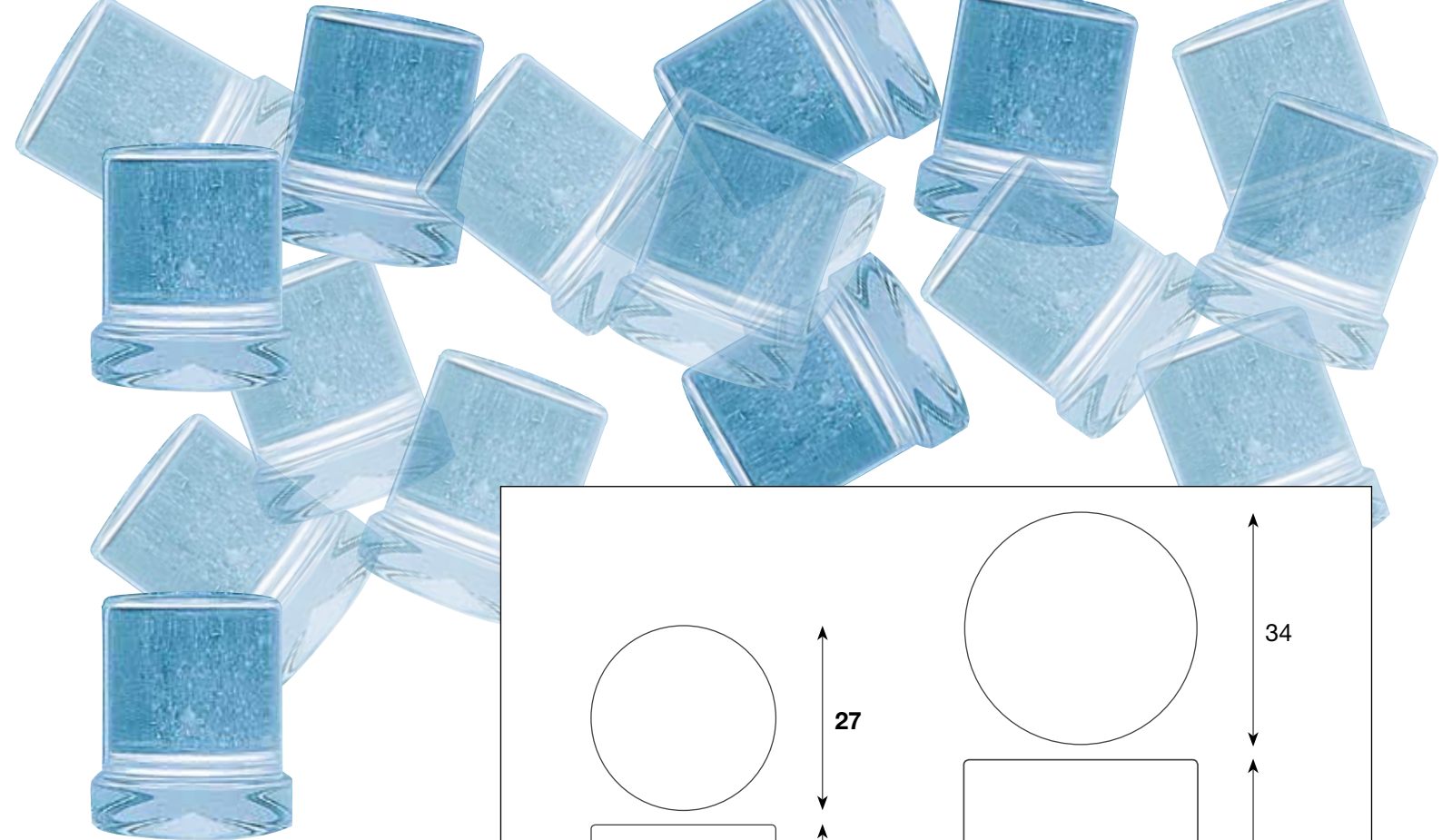

**SERIE KL**

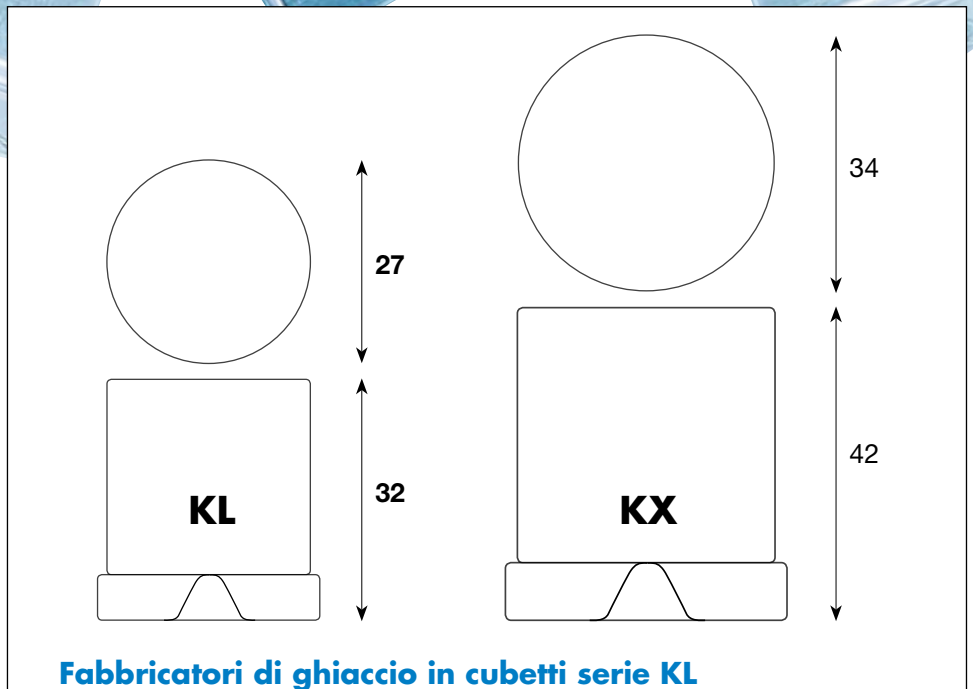

### **Fabbricatori di ghiaccio in cubetti serie KL**

Ideale per il raffreddamento di bevande, bottiglie e tante altre applicazioni nei bar, ristoranti, ecc.

### **Machines à glaçons série KL**

Ideal pour le refroidissement de boissons, bouteilles et beaucoup d'autres applications dans les bar, les restaurants, etc.

### **Ice cube machines series KL**

Ideal for cooling drinks, bottles and many other applications in bars, restaurants, and so on.

### **Fabricadores de hielo en cubitos serie KL**

Ideal para el enfriamiento de bebidas, botellas y para muchas otras aplicaciones en bares, restaurantes, etc.

### **Eiswürfelbereiter Serie KL**

Ideal zur Kühlung von Getränken, Flaschen und anderem in Bars, Restaurants usw.

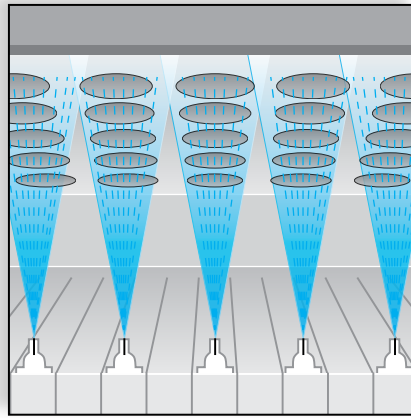

KL 18		A	W
Produzione • Production • Production Produccion • Tagesleistung	*Kg/24h Lb/24h	21 46	22 48
Capacità contenitore • Capacité bac • Bin capacity Capacidad del deposito • Behälterkapazität	Kg - Lb	6,5 - 14,3	
Produzione di cubetti • Production de glaçons Production of ice cubes • Producción cubitos Tagesleistung in Eiswürfel	n°/24h	1166	1222
Capacità contenitore di cubetti • Capacité bac de glaçons Bin capacity of ice cubes • Capacidad cubitos del deposito Behälterkapazität Eiswürfel	n°	360	
Assorbimento • Consommation • Power Potencia • Leistungsaufnahme	(T=43°C)-W	350	
Peso netto • Poids net • Net weight Peso neto • Nettogewicht	Kg	29	
Voltaggio standard • Voltage standard • Standard voltage Voltaje • Anschlußspannung		V230/50Hz/1	

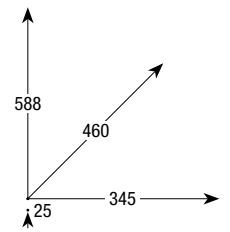

KL 20		A	W
Produzione • Production • Production Produccion • Tagesleistung	*Kg/24h Lb/24h	21 46	22 48
Capacità contenitore • Capacité bac • Bin capacity Capacidad del deposito • Behälterkapazität	Kg - Lb	6,5 - 14,3	
Produzione di cubetti • Production de glaçons Production of ice cubes • Producción cubitos Tagesleistung in Eiswürfel	n°/24h	1166	1222
Capacità contenitore di cubetti • Capacité bac de glaçons Bin capacity of ice cubes • Capacidad cubitos del deposito Behälterkapazität Eiswürfel	n°	360	
Assorbimento • Consommation • Power Potencia • Leistungsaufnahme	(T=43°C)-W	350	
Peso netto • Poids net • Net weight Peso neto • Nettogewicht	Kg	29	
Voltaggio standard • Voltage standard • Standard voltage Voltaje • Anschlußspannung		V230/50Hz/1	

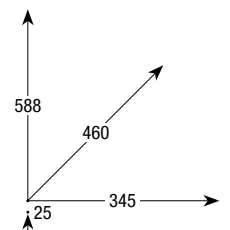

KL 22		A	W
Produzione • Production • Production Produccion • Tagesleistung	*Kg/24h Lb/24h	24 52	25 55
Capacità contenitore • Capacité bac • Bin capacity Capacidad del deposito • Behälterkapazität	Kg - Lb	6,5 - 14,3	
Produzione di cubetti • Production de glaçons Production of ice cubes • Producción cubitos Tagesleistung in Eiswürfel	n°/24h	1333	1388
Capacità contenitore di cubetti • Capacité bac de glaçons Bin capacity of ice cubes • Capacidad cubitos del deposito Behälterkapazität Eiswürfel	n°	360	
Assorbimento • Consommation • Power Potencia • Leistungsaufnahme	(T=43°C)-W	350	
Peso netto • Poids net • Net weight Peso neto • Nettogewicht	Kg	32	
Voltaggio standard • Voltage standard • Standard voltage Voltaje • Anschlußspannung		V230/50Hz/1	

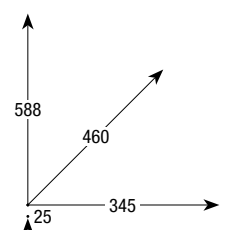

<b>KL 32</b>		A	W
Produzione • Production • Production Produccion • Tagesleistung	*Kg/24h Lb/24h	30 66	31 68
Capacità contenitore • Capacité bac • Bin capacity Capacidad del deposito • Behälterkapazität	Kg - Lb	11 - 24,2	
Produzione di cubetti • Production de glaçons Production of ice cubes • Producción cubitos Tagesleistung in Eiswürfel	n°/24h	1660	1720
Capacità contenitore di cubetti • Capacité bac de glaçons Bin capacity of ice cubes • Capacidad cubitos del deposito Behälterkapazität Eiswürfel	KL n° KX	610	310
Assorbimento • Consommation • Power Potencia • Leistungsaufnahme	(T=43°C)-W	420	
Peso netto • Poids net • Net weight Peso neto • Nettogewicht	Kg	39	
Voltaggio standard • Voltage standard • Standard voltage Voltaje • Anschlußspannung		V230/50Hz/1	

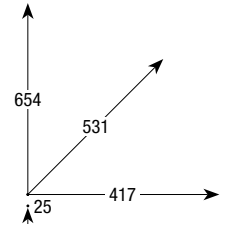

<b>KL 42</b>		A	W
Produzione • Production • Production Produccion • Tagesleistung	*Kg/24h Lb/24h	40 88	42 92
Capacità contenitore • Capacité bac • Bin capacity Capacidad del deposito • Behälterkapazität	Kg - Lb	17 - 37,4	
Produzione di cubetti • Production de glaçons Production of ice cubes • Producción cubitos Tagesleistung in Eiswürfel	n°/24h	2220	2330
Capacità contenitore di cubetti • Capacité bac de glaçons Bin capacity of ice cubes • Capacidad cubitos del deposito Behälterkapazität Eiswürfel	KL n° KX	940	490
Assorbimento • Consommation • Power Potencia • Leistungsaufnahme	(T=43°C)-W	455	
Peso netto • Poids net • Net weight Peso neto • Nettogewicht	Kg	50	
Voltaggio standard • Voltage standard • Standard voltage Voltaje • Anschlußspannung		V230/50Hz/1	

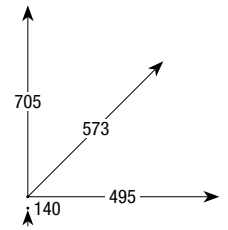

<b>KL 52</b>		A	W
Produzione • Production • Production Produccion • Tagesleistung	*Kg/24h Lb/24h	50 110	52 115
Capacità contenitore • Capacité bac • Bin capacity Capacidad del deposito • Behälterkapazität	Kg - Lb	20 - 44	
Produzione di cubetti • Production de glaçons Production of ice cubes • Producción cubitos Tagesleistung in Eiswürfel	n°/24h	2770	2880
Capacità contenitore di cubetti • Capacité bac de glaçons Bin capacity of ice cubes • Capacidad cubitos del deposito Behälterkapazität Eiswürfel	KL n° KX	1100	580
Assorbimento • Consommation • Power Potencia • Leistungsaufnahme	(T=43°C)-W	475	
Peso netto • Poids net • Net weight Peso neto • Nettogewicht	Kg	51	
Voltaggio standard • Voltage standard • Standard voltage Voltaje • Anschlußspannung		V230/50Hz/1	

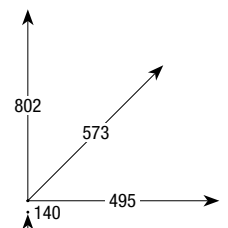

<b>KL 62</b>		A	W
Produzione • Production • Production Produccion • Tagesleistung	*Kg/24h Lb/24h	60 132	62 136
Capacità contenitore • Capacité bac • Bin capacity Capacidad del deposito • Behälterkapazität	Kg - Lb	20 - 44	
Produzione di cubetti • Production de glaçons Production of ice cubes • Producción cubitos Tagesleistung in Eiswürfel	n°/24h	3330	3440
Capacità contenitore di cubetti • Capacité bac de glaçons Bin capacity of ice cubes • Capacidad cubitos del deposito Behälterkapazität Eiswürfel	KL n° KX	1100	580
Assorbimento • Consommation • Power Potencia • Leistungsaufnahme	(T=43°C)-W	730	
Peso netto • Poids net • Net weight Peso neto • Nettogewicht	Kg	54	
Voltaggio standard • Voltage standard • Standard voltage Voltaje • Anschlußspannung		V230/50Hz/1	

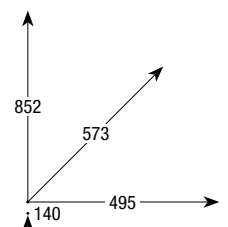

KL 72		A	W
Produzione • Production • Production Produccion • Tagesleistung	*Kg/24h Lb/24h	70 154	72 159
Capacità contenitore • Capacité bac • Bin capacity Capacidad del deposito • Behälterkapazität	Kg - Lb	30 - 66	
Produzione di cubetti • Production de glaçons Production of ice cubes • Producción cubitos Tagesleistung in Eiswürfel	n°/24h	3880	4000
Capacità contenitore di cubetti • Capacité bac de glaçons Bin capacity of ice cubes • Capacidad cubitos del deposito Behälterkapazität Eiswürfel	KL n° KX	1660	860
Assorbimento • Consommation • Power Potencia • Leistungsaufnahme	(T=43°C)-W	730	
Peso netto • Poids net • Net weight Peso neto • Nettogewicht	Kg	66	
Voltaggio standard • Voltage standard • Standard voltage Voltaje • Anschlußspannung		V230/50Hz/1	

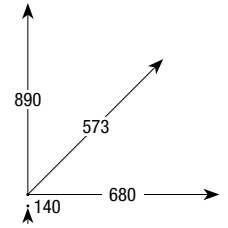

KL 102		A	W
Produzione • Production • Production Produccion • Tagesleistung	*Kg/24h Lb/24h	88 194	90 198
Capacità contenitore • Capacité bac • Bin capacity Capacidad del deposito • Behälterkapazität	Kg - Lb	45 - 99	
Produzione di cubetti • Production de glaçons Production of ice cubes • Producción cubitos Tagesleistung in Eiswürfel	n°/24h	4880	5000
Capacità contenitore di cubetti • Capacité bac de glaçons Bin capacity of ice cubes • Capacidad cubitos del deposito Behälterkapazität Eiswürfel	KL n° KX	2500	1290
Assorbimento • Consommation • Power Potencia • Leistungsaufnahme	(T=43°C)-W	900	
Peso netto • Poids net • Net weight Peso neto • Nettogewicht	Kg	69	
Voltaggio standard • Voltage standard • Standard voltage Voltaje • Anschlußspannung		V230/50Hz/1	

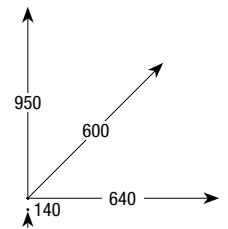

KL 132		A	W
Produzione • Production • Production Produccion • Tagesleistung	*Kg/24h Lb/24h	125 275	127 280
Capacità contenitore • Capacité bac • Bin capacity Capacidad del deposito • Behälterkapazität	Kg - Lb	65 - 143	
Produzione di cubetti • Production de glaçons Production of ice cubes • Producción cubitos Tagesleistung in Eiswürfel	n°/24h	6940	7050
Capacità contenitore di cubetti • Capacité bac de glaçons Bin capacity of ice cubes • Capacidad cubitos del deposito Behälterkapazität Eiswürfel	KL n° KX	3610	1860
Assorbimento • Consommation • Power Potencia • Leistungsaufnahme	(T=43°C)-W	1200	
Peso netto • Poids net • Net weight Peso neto • Nettogewicht	Kg	99	
Voltaggio standard • Voltage standard • Standard voltage Voltaje • Anschlußspannung		V230/50Hz/1	

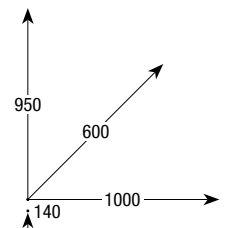

KL 152		A	W
Produzione • Production • Production Produccion • Tagesleistung	*Kg/24h Lb/24h	145 319	147 324
Capacità contenitore • Capacité bac • Bin capacity Capacidad del deposito • Behälterkapazität	Kg - Lb	65 - 143	
Produzione di cubetti • Production de glaçons Production of ice cubes • Producción cubitos Tagesleistung in Eiswürfel	n°/24h	8050	8160
Capacità contenitore di cubetti • Capacité bac de glaçons Bin capacity of ice cubes • Capacidad cubitos del deposito Behälterkapazität Eiswürfel	KL n° KX	3610	1860
Assorbimento • Consommation • Power Potencia • Leistungsaufnahme	(T=43°C)-W	1350	
Peso netto • Poids net • Net weight Peso neto • Nettogewicht	Kg	101	
Voltaggio standard • Voltage standard • Standard voltage Voltaje • Anschlußspannung		V230/50Hz/1	

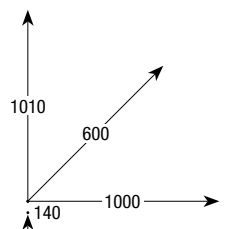

<b>KL 172</b>		A	W
Produzione • Production • Production Produccion • Tagesleistung	*Kg/24h Lb/24h	150 330	152 335
Produzione di cubetti • Production de glaçons Production of ice cubes • Producción cubitos Tagesleistung in Eiswürfel	n°/24h	KL KX	8330 8440 4280 4340
Contenitore • Bac • Bin • Deposito • Behälter		B/BL 150 • B/BE/BL 150 B/BL 250	
Assorbimento • Consommation • Power Potencia • Leistungsaufnahme	(T=43°C)-W	1500	
Peso netto • Poids net • Net weight Peso neto • Nettogewicht	Kg	82	
Voltaggio standard • Voltage standard • Standard voltage Voltaje • Anschlußspannung		V230/50Hz/1	



<b>KL 302</b>		A	W
Produzione • Production • Production Produccion • Tagesleistung	*Kg/24h Lb/24h	260 572	262 576
Produzione di cubetti • Production de glaçons Production of ice cubes • Producción cubitos Tagesleistung in Eiswürfel	n°/24h	KL KX	14440 14550 7420 7480
Contenitore • Bac • Bin • Deposito • Behälter		B/BL 150 • B/BL 250 B/BE/BL 250	
Assorbimento • Consommation • Power Potencia • Leistungsaufnahme	(T=43°C)-W	2400	
Peso netto • Poids net • Net weight Peso neto • Nettogewicht	Kg	136	
Voltaggio standard • Voltage standard • Standard voltage Voltaje • Anschlußspannung		V230/50Hz/1	





**SERIE** **KD**

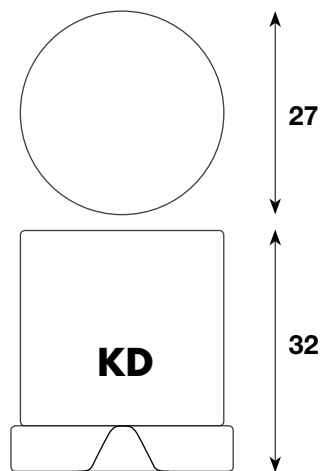

#### **Distributore di ghiaccio in cubetti serie KD**

Ideale per il raffreddamento di bevande, bottiglie e tante altre applicazioni nei bar, ristoranti, ecc.

#### **Distributeur à glaçons série KD**

Ideal pour le refroidissement de boissons, bouteilles et beaucoup d'autres applications dans les bar, les restaurants, ecc.

#### **Ice cube dispenser series KD**

Ideal for cooling drinks, bottles and many other applications in bars, restaurants, and so on.

#### **Maquina distribudore de hielo en cubitos serie KD**

Ideal para el enfriamiento de bebidas, botellas y para muchas otras aplicaciones en bares, restaurantes, etc.

#### **Eiswürfeldispenser Serie KD**

Ideal zur Kühlung von Getränken, Flaschen und anderem in Bars, Restaurants usw.



KD 3		A	W
Produzione • Production • Production Produccion • Tagesleistung	*Kg/24h Lb/24h	30 66	31 68
Capacità contenitore • Capacité bac • Bin capacity Capacidad del deposito • Behälterkapazität	Kg - Lb	13 - 28	
Produzione di cubetti • Production de glaçons Production of ice cubes • Producción cubitos Tagesleistung in Eiswürfel	n°/24h	1666 1722	
Capacità contenitore di cubetti • Capacité bac de glaçons Bin capacity of ice cubes • Capacidad cubitos del deposito Behälterkapazität Eiswürfel	n°	722	
Assorbimento • Consommation • Power Potencia • Leistungsaufnahme	(T=43°C)-W	420	
Peso netto • Poids net • Net weight Peso neto • Nettogewicht	Kg	46	
Voltaggio standard • Voltage standard • Standard voltage Voltaje • Anschlußspannung		V230/50Hz/1	

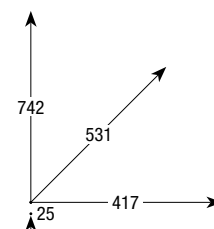

KD 30		A	W
Produzione • Production • Production Produccion • Tagesleistung	*Kg/24h Lb/24h	30 66	31 68
Capacità contenitore • Capacité bac • Bin capacity Capacidad del deposito • Behälterkapazität	Kg - Lb	13 - 28	
Produzione di cubetti • Production de glaçons Production of ice cubes • Producción cubitos Tagesleistung in Eiswürfel	n°/24h	1666 1722	
Capacità contenitore di cubetti • Capacité bac de glaçons Bin capacity of ice cubes • Capacidad cubitos del deposito Behälterkapazität Eiswürfel	n°	722	
Assorbimento • Consommation • Power Potencia • Leistungsaufnahme	(T=43°C)-W	420	
Peso netto • Poids net • Net weight Peso neto • Nettogewicht	Kg	59	
Voltaggio standard • Voltage standard • Standard voltage Voltaje • Anschlußspannung		V230/50Hz/1	

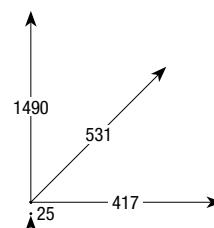

**KD 30**  
a richiesta • sur demande • on request  
a petición • auf Anfrage



**SERIE** KP

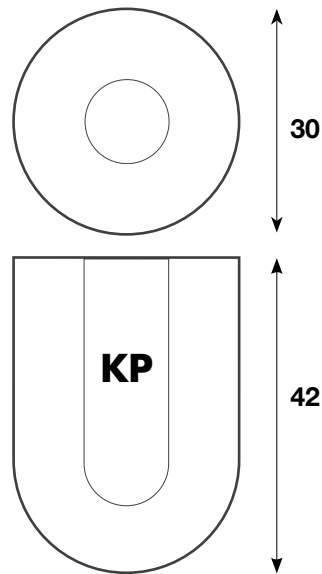

### **Fabbricatori di ghiaccio in cubetti serie KP**

Il cubetto di ghiaccio cavo con grande superficie della serie KP è ideale per l'immediato raffreddamento di **bevande, bottiglie e altre applicazioni nei bar, ristoranti ecc.**

### **Machines à glaçons série KP**

Le glaçon de la série KP est idéal pour le refroidissement rapide de **boissons, bouteilles et beaucoup d'autres applications dans les bar, les restaurants ecc.**

### **Ice cube machines series KP**

The ice cube of series KP is ideal for cooling rapid **drinks, bottles and many other applications in bars, restaurants, and so on.**

### **Fabricadores de hielo en cubitos serie KP**

El cubito de hielo de la serie KP es ideal para el enfriamiento rápido de **bebidas, botellas y para muchas otras aplicaciones en bares, restaurantes, etc.**

### **Eiswürfelbereiter Serie KP**

Der Eiswürfel Serie KP ist ideal zur schnellen Kühlung von **Getränken, Flaschen und anderem in Bars, Restaurants usw.**

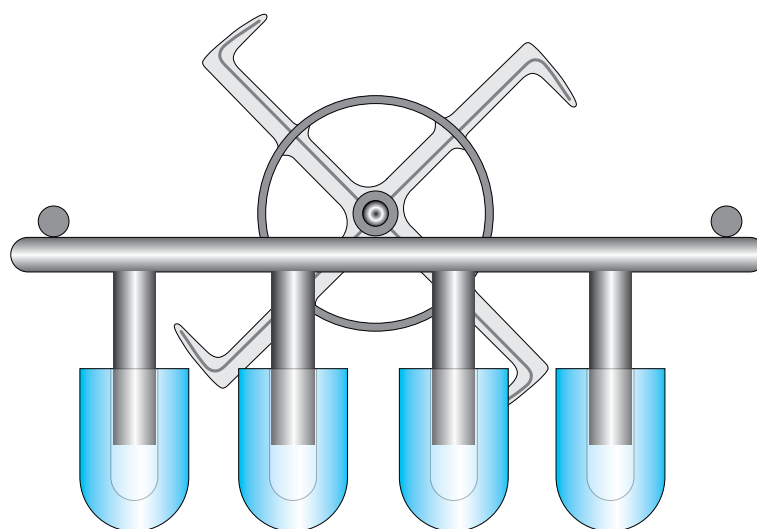
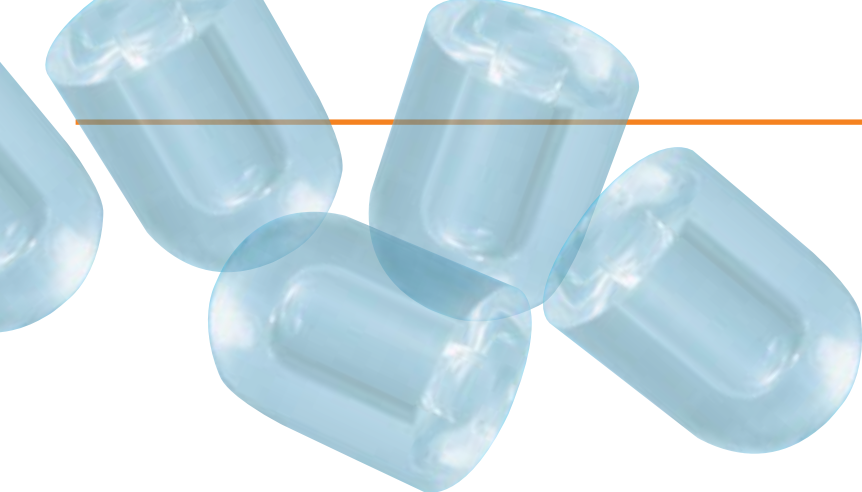

<b>KP 20</b>		A	W
Produzione • Production • Production Produccion • Tagesleistung	*Kg/24h Lb/24h	21 46	22 48
Capacità contenitore • Capacité bac • Bin capacity Capacidad del deposito • Behälterkapazität	Kg - Lb	8 - 17,6	
Produzione di cubetti • Production de glaçons Production of ice cubes • Producción cubitos Tagesleistung in Eiswürfel	n°/24h	1050	1100
Capacità contenitore di cubetti • Capacité bac de glaçons Bin capacity of ice cubes • Capacidad cubitos del deposito Behälterkapazität Eiswürfel	n°	400	
Assorbimento • Consommation • Power Potencia • Leistungsaufnahme	(T=43°C)-W	290	
Peso netto • Poids net • Net weight Peso neto • Nettogewicht	Kg	32	
Voltaggio standard • Voltage standard • Standard voltage Voltaje • Anschlußspannung		V230/50Hz/1	

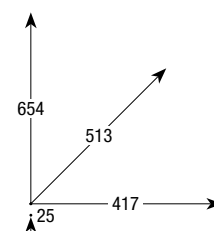

<b>KP 30</b>		A	W
Produzione • Production • Production Produccion • Tagesleistung	*Kg/24h Lb/24h	28 62	29 64
Capacità contenitore • Capacité bac • Bin capacity Capacidad del deposito • Behälterkapazität	Kg - Lb	11 - 24,5	
Produzione di cubetti • Production de glaçons Production of ice cubes • Producción cubitos Tagesleistung in Eiswürfel	n°/24h	1400	1450
Capacità contenitore di cubetti • Capacité bac de glaçons Bin capacity of ice cubes • Capacidad cubitos del deposito Behälterkapazität Eiswürfel	n°	550	
Assorbimento • Consommation • Power Potencia • Leistungsaufnahme	(T=43°C)-W	350	
Peso netto • Poids net • Net weight Peso neto • Nettogewicht	Kg	39	
Voltaggio standard • Voltage standard • Standard voltage Voltaje • Anschlußspannung		V230/50Hz/1	

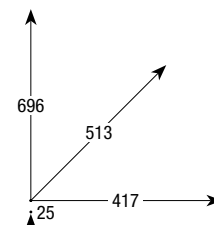

<b>KP 40</b>		A	W
Produzione • Production • Production Produccion • Tagesleistung	*Kg/24h Lb/24h	37 81	39 85
Capacità contenitore • Capacité bac • Bin capacity Capacidad del deposito • Behälterkapazität	Kg - Lb	13 - 28,6	
Produzione di cubetti • Production de glaçons Production of ice cubes • Producción cubitos Tagesleistung in Eiswürfel	n°/24h	1850	1950
Capacità contenitore di cubetti • Capacité bac de glaçons Bin capacity of ice cubes • Capacidad cubitos del deposito Behälterkapazität Eiswürfel	n°	650	
Assorbimento • Consommation • Power Potencia • Leistungsaufnahme	(T=43°C)-W	420	
Peso netto • Poids net • Net weight Peso neto • Nettogewicht	Kg	41	
Voltaggio standard • Voltage standard • Standard voltage Voltaje • Anschlußspannung		V230/50Hz/1	

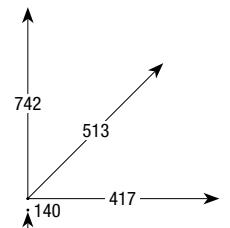

<b>KP 50</b>		A	W
Produzione • Production • Production Produccion • Tagesleistung	*Kg/24h Lb/24h	47 103	49 107
Capacità contenitore • Capacité bac • Bin capacity Capacidad del deposito • Behälterkapazität	Kg - Lb	17 - 37	
Produzione di cubetti • Production de glaçons Production of ice cubes • Producción cubitos Tagesleistung in Eiswürfel	n°/24h	2350	2450
Capacità contenitore di cubetti • Capacité bac de glaçons Bin capacity of ice cubes • Capacidad cubitos del deposito Behälterkapazität Eiswürfel	n°	850	
Assorbimento • Consommation • Power Potencia • Leistungsaufnahme	(T=43°C)-W	455	
Peso netto • Poids net • Net weight Peso neto • Nettogewicht	Kg	52	
Voltaggio standard • Voltage standard • Standard voltage Voltaje • Anschlußspannung		V230/50Hz/1	

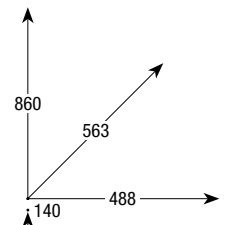

<b>KP 60</b>		A	W
Produzione • Production • Production Produccion • Tagesleistung	*Kg/24h Lb/24h	57 125	59 129
Capacità contenitore • Capacité bac • Bin capacity Capacidad del deposito • Behälterkapazität	Kg - Lb	17 - 37	
Produzione di cubetti • Production de glaçons Production of ice cubes • Producción cubitos Tagesleistung in Eiswürfel	n°/24h	2850	2950
Capacità contenitore di cubetti • Capacité bac de glaçons Bin capacity of ice cubes • Capacidad cubitos del deposito Behälterkapazität Eiswürfel	n°	850	
Assorbimento • Consommation • Power Potencia • Leistungsaufnahme	(T=43°C)-W	475	
Peso netto • Poids net • Net weight Peso neto • Nettogewicht	Kg	52	
Voltaggio standard • Voltage standard • Standard voltage Voltaje • Anschlußspannung		V230/50Hz/1	

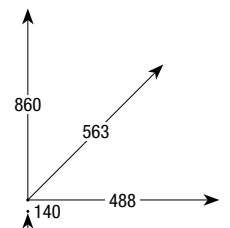

<b>KP 70</b>		A	W
Produzione • Production • Production Produccion • Tagesleistung	*Kg/24h Lb/24h	67 147	69 151
Capacità contenitore • Capacité bac • Bin capacity Capacidad del deposito • Behälterkapazität	Kg - Lb	30 - 66	
Produzione di cubetti • Production de glaçons Production of ice cubes • Producción cubitos Tagesleistung in Eiswürfel	n°/24h	3350	3450
Capacità contenitore di cubetti • Capacité bac de glaçons Bin capacity of ice cubes • Capacidad cubitos del deposito Behälterkapazität Eiswürfel	n°	1500	
Assorbimento • Consommation • Power Potencia • Leistungsaufnahme	(T=43°C)-W	730	
Peso netto • Poids net • Net weight Peso neto • Nettogewicht	Kg	68	
Voltaggio standard • Voltage standard • Standard voltage Voltaje • Anschlußspannung		V230/50Hz/1	

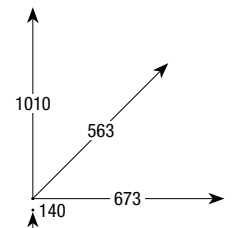

<b>KP 90</b>		A	W
Produzione • Production • Production Produccion • Tagesleistung	*Kg/24h Lb/24h	86 189	88 193
Capacità contenitore • Capacité bac • Bin capacity Capacidad del deposito • Behälterkapazität	Kg - Lb	30 - 66	
Produzione di cubetti • Production de glaçons Production of ice cubes • Producción cubitos Tagesleistung in Eiswürfel	n°/24h	4300	4400
Capacità contenitore di cubetti • Capacité bac de glaçons Bin capacity of ice cubes • Capacidad cubitos del deposito Behälterkapazität Eiswürfel	n°	1500	
Assorbimento • Consommation • Power Potencia • Leistungsaufnahme	(T=43°C)-W	900	
Peso netto • Poids net • Net weight Peso neto • Nettogewicht	Kg	68	
Voltaggio standard • Voltage standard • Standard voltage Voltaje • Anschlußspannung		V230/50Hz/1	

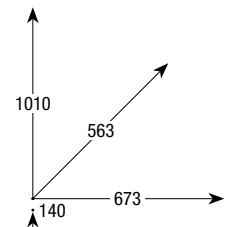

<b>KP 120</b>		A	W
Produzione • Production • Production Produccion • Tagesleistung	*Kg/24h Lb/24h	125 275	127 280
Capacità contenitore • Capacité bac • Bin capacity Capacidad del deposito • Behälterkapazität	Kg - Lb	45 - 99	
Produzione di cubetti • Production de glaçons Production of ice cubes • Producción cubitos Tagesleistung in Eiswürfel	n°/24h	6250	6350
Capacità contenitore di cubetti • Capacité bac de glaçons Bin capacity of ice cubes • Capacidad cubitos del deposito Behälterkapazität Eiswürfel	n°	2250	
Assorbimento • Consommation • Power Potencia • Leistungsaufnahme	(T=43°C)-W	1100	
Peso netto • Poids net • Net weight Peso neto • Nettogewicht	Kg	92	
Voltaggio standard • Voltage standard • Standard voltage Voltaje • Anschlußspannung		V230/50Hz/1	

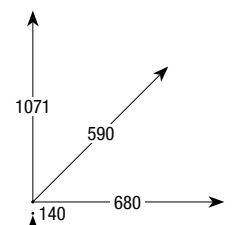

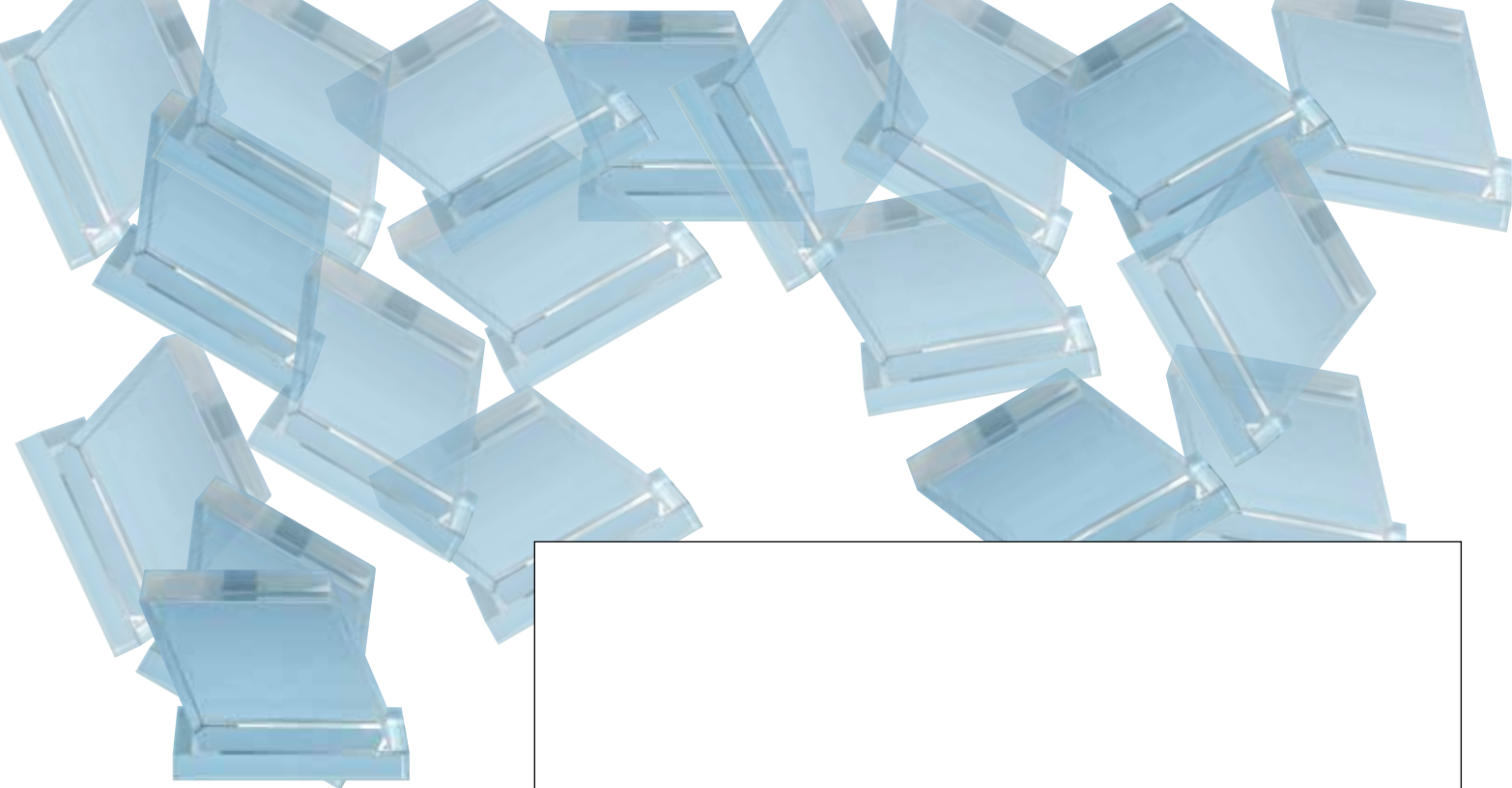

**SERIE** **KVB**

**SERIE** **KV**

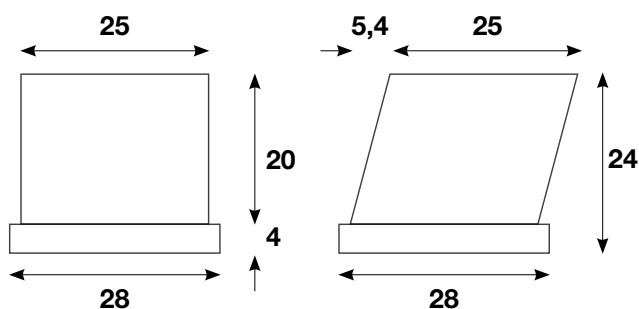

### Fabbricatori di ghiaccio in cubetti serie KVB/KV

Cristallino, igienico e compatto è ideale per il raffreddamento di bevande, bottiglie e tante altre applicazioni dove si ha bisogno di grosse quantità di ghiaccio in poco tempo.

Vedi Bar, Hotel, Restaurant, Fast Food, ecc.

### Machines à glaçons série KVB/KV

Cristallin, hygiénique et compact, est l'idéal pour refroidir des boissons, des bouteilles et pour de nombreuses autres applications nécessitant de grandes quantités de glace en peu de temps.

Par exemple Bars, Hotels, Restaurants, Fast Food, etc.

### Ice cube machines series KVB/KV

Crystalline, hygienic and compact, ideal for cooling beverages, bottles and for other uses where large amounts of ice are required quickly.

See Bar, Hotel, Restaurant, Fast Food, etc.

### Fabricadores de hielo en cubitos serie KVB/KV

Cristalino, higiénico y compacto es ideal para enfriar bebidas, botellas y tantas otras aplicaciones donde se necesite grandes cantidades de hielo en poco tiempo, *por ejemplo*, Bares, Hoteles, Restaurantes, Fast Food, etc.

### Eiswürfelbereiter Serie KVB/KV

Kristallin, hygienisch und kompakt und ideal zur Kühlung von Getränken, Flaschen sowie einer Vielzahl von weiteren Anwendungsformen, bei denen große Mengen von Eis in kürzester Zeit benötigt werden. *Siehe* Bars, Hotels, Restaurants, Fast Food, etc.

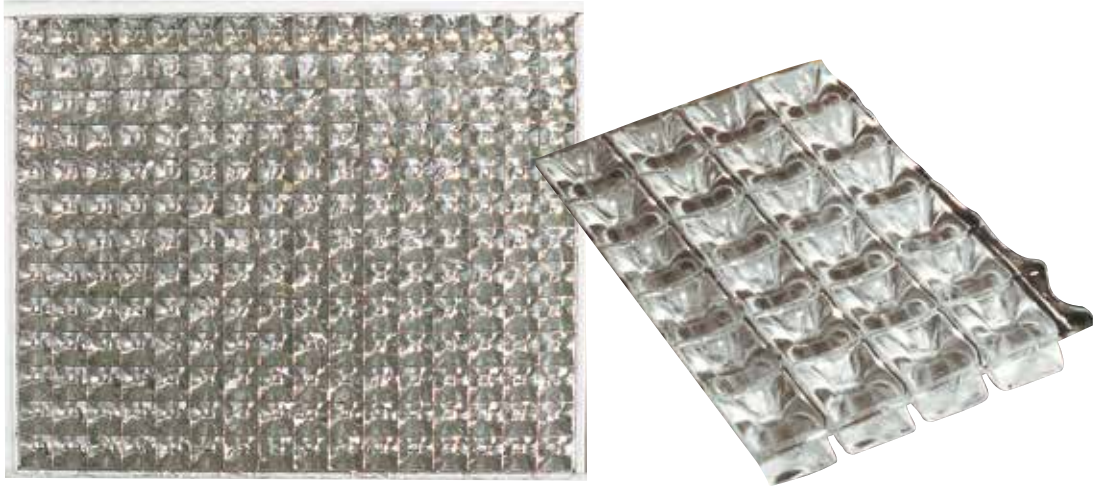

<b>KVB 40</b>		A	W
Produzione • Production • Production Produccion • Tagesleistung	*Kg/24h Lb/24h	39 86	41 90
Capacità contenitore • Capacité bac • Bin capacity Capacidad del deposito • Behälterkapazität	Kg - Lb	17 - 38	
Produzione di cubetti • Production de glaçons Production of ice cubes • Producción cubitos Tagesleistung in Eiswürfel	n°/24h	2785	3416
Capacità contenitore di cubetti • Capacité bac de glaçons Bin capacity of ice cubes • Capacidad cubitos del deposito Behälterkapazität Eiswürfel	n°	1416	
Assorbimento • Consommation • Power Potencia • Leistungsaufnahme	(T=43°C)-W	475	
Peso netto • Poids net • Net weight Peso neto • Nettogewicht	Kg	47	
Votaggio standard • Voltage standard • Standard voltage Voltaje • Anschlußspannung		V230/50Hz/1	

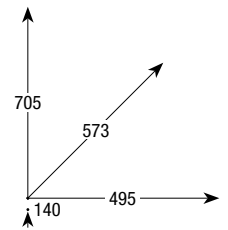

<b>KVB 80</b>		A	W
Produzione • Production • Production Produccion • Tagesleistung	*Kg/24h Lb/24h	79 174	81 178
Capacità contenitore • Capacité bac • Bin capacity Capacidad del deposito • Behälterkapazität	Kg - Lb	30 - 66	
Produzione di cubetti • Production de glaçons Production of ice cubes • Producción cubitos Tagesleistung in Eiswürfel	n°/24h	6583	6750
Capacità contenitore di cubetti • Capacité bac de glaçons Bin capacity of ice cubes • Capacidad cubitos del deposito Behälterkapazität Eiswürfel	n°	2500	
Assorbimento • Consommation • Power Potencia • Leistungsaufnahme	(T=43°C)-W	1050	
Peso netto • Poids net • Net weight Peso neto • Nettogewicht	Kg	66	
Votaggio standard • Voltage standard • Standard voltage Voltaje • Anschlußspannung		V230/50Hz/1	

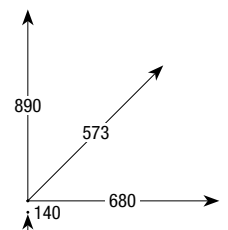

<b>KVB 120</b>		A	W
Produzione • Production • Production Produccion • Tagesleistung	*Kg/24h Lb/24h	125 275	127 280
Capacità contenitore • Capacité bac • Bin capacity Capacidad del deposito • Behälterkapazität	Kg - Lb	45 - 99	
Produzione di cubetti • Production de glaçons Production of ice cubes • Producción cubitos Tagesleistung in Eiswürfel	n°/24h	10416	10583
Capacità contenitore di cubetti • Capacité bac de glaçons Bin capacity of ice cubes • Capacidad cubitos del deposito Behälterkapazität Eiswürfel	n°	3750	
Assorbimento • Consommation • Power Potencia • Leistungsaufnahme	(T=43°C)-W	1350	
Peso netto • Poids net • Net weight Peso neto • Nettogewicht	Kg	80	
Votaggio standard • Voltage standard • Standard voltage Voltaje • Anschlußspannung		V230/50Hz/1	

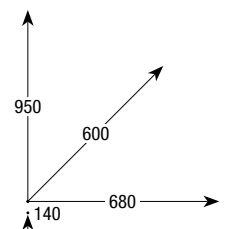

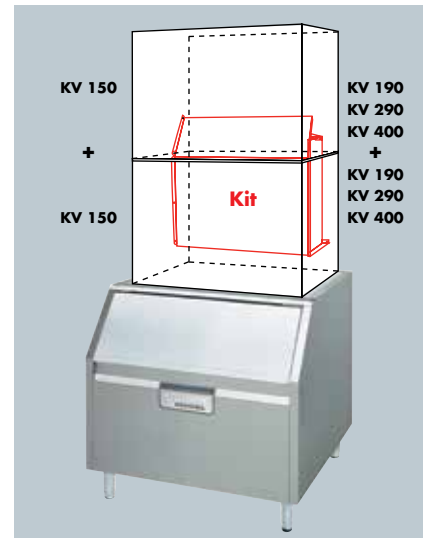
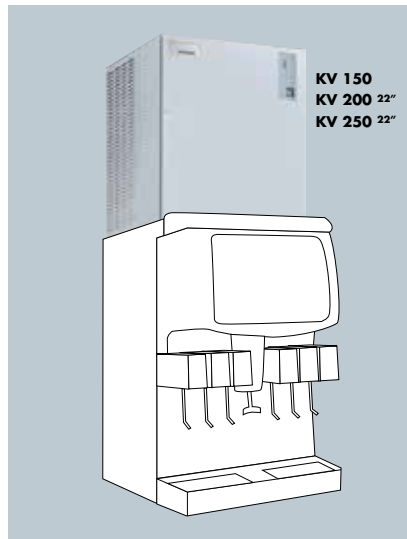

KV 150		A	W
Produzione • Production • Production Produccion • Tagesleistung	*Kg/24h Lb/24h	140 308	145 319
Produzione di cubetti • Production de glaçons Production of ice cubes • Producción cubitos Tagesleistung in Eiswürfel	n°/24h	11670	12090
Contenitore • Bac • Bin • Deposito • Behälter		B/BV 100	
Assorbimento • Consommation • Power Potencia • Leistungsaufnahme	(T=43°C)-W	900	
Peso netto • Poids net • Net weight Peso neto • Nettogewicht	Kg	61	
Voltaggio standard • Voltage standard • Standard voltage Voltaje • Anschlußspannung		V230/50Hz/1	

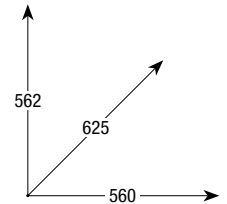

KV 190		A	W
Produzione • Production • Production Produccion • Tagesleistung	*Kg/24h Lb/24h	195 429	200 440
Produzione di cubetti • Production de glaçons Production of ice cubes • Producción cubitos Tagesleistung in Eiswürfel	n°/24h	16250	16670
Contenitore • Bac • Bin • Deposito • Behälter		B/BV 150 B/BE/BV 150 B/BV 250	
Assorbimento • Consommation • Power Potencia • Leistungsaufnahme	(T=43°C)-W	1100	
Peso netto • Poids net • Net weight Peso neto • Nettogewicht	Kg	70	
Voltaggio standard • Voltage standard • Standard voltage Voltaje • Anschlußspannung		V230/50Hz/1	

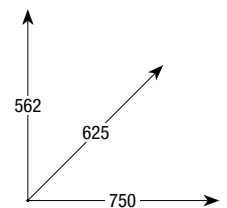



KV 290		A	W
Produzione • Production • Production Produccion • Tagesleistung	*Kg/24h Lb/24h	290 638	295 649
Produzione di cubetti • Production de glaçons Production of ice cubes • Producción cubitos Tagesleistung in Eiswürfel	n°/24h	24170 24590	
Contenitore • Bac • Bin • Deposito • Behälter	B/BV 150 • B/BE/BV 150 B/BV 250 • B/BE/BV 250		
Assorbimento • Consommation • Power Potencia • Leistungsaufnahme	(T=43°C)-W	1500	
Peso netto • Poids net • Net weight Peso neto • Nettogewicht	Kg	80	
Voltaggio standard • Voltage standard • Standard voltage Voltaje • Anschlußspannung		V230/50Hz/1	

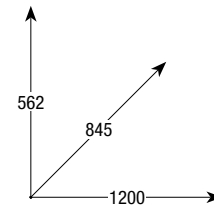

KV 400		A	W
Produzione • Production • Production Produccion • Tagesleistung	*Kg/24h Lb/24h	385 847	395 869
Produzione di cubetti • Production de glaçons Production of ice cubes • Producción cubitos Tagesleistung in Eiswürfel	n°/24h	32080 32910	
Contenitore • Bac • Bin • Deposito • Behälter	B/BV 150 • B/BE/BV 150 B/BV 250 • B/BE/BV 250		
Assorbimento • Consommation • Power Potencia • Leistungsaufnahme	(T=43°C)-W	2400	
Peso netto • Poids net • Net weight Peso neto • Nettogewicht	Kg	101	
Voltaggio standard • Voltage standard • Standard voltage Voltaje • Anschlußspannung		V230/50Hz/1	

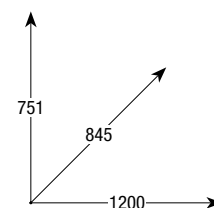



### **Fabbricatori di ghiaccio granulare serie KF**

Il ghiaccio granulare della serie KF è ideale per l'uso nei bar, laboratori, ospedali, panifici, macellerie, pescherie, fast food e ristoranti.

### **Machines à glace en grains série KF**

La glace en grains serie KF est idéale pour bar, laboratoires, hôpitaux, boulangeries, boucheries, poissonneries, Fast Food et restaurants.

### **Ice flake machines series KF**

The ice flake of series KF is ideal for bar, laboratories, hospitals, bakeries, butchers, fishmongers, Fast Food outlets and restaurants.

### **Fabricadores de hielo granular serie KF**

El hielo granular ideal para bar, laboratorios, hospitales, panificadores, carnicerías, pescaderías, Fast Food y restaurantes.

### **Eisflockenbereiter Serie KF**

Die Eisflocke der Serie KF ist ideal für den Gebrauch in Bar, Laboratorien, Krankenhäusern, Bäckereien, Fleischereien, Fischhandel, Fast Food und Restaurants.

<b>KF 45</b>		A	W
Produzione • Production • Production Produccion • Tagesleistung	*Kg/24h Lb/24h	40 88	42 92
Capacità contenitore • Capacité bac • Bin capacity Capacidad del deposito • Behälterkapazität	Kg - Lb	10 - 22	
Assorbimento • Consommation • Power Potencia • Leistungsaufnahme	(T=43°C)-W	410	
Peso netto • Poids net • Net weight Peso neto • Nettogewicht	Kg	39	
Voltaggio standard • Voltage standard • Standard voltage Voltaje • Anschlußspannung		V230/50Hz/1	

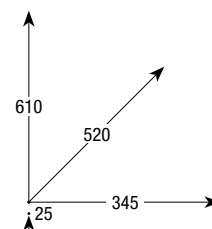

<b>KF 85</b>		A	W
Produzione • Production • Production Produccion • Tagesleistung	*Kg/24h Lb/24h	80 176	83 183
Capacità contenitore • Capacité bac • Bin capacity Capacidad del deposito • Behälterkapazität	Kg - Lb	25 - 55	
Assorbimento • Consommation • Power Potencia • Leistungsaufnahme	(T=43°C)-W	520	
Peso netto • Poids net • Net weight Peso neto • Nettogewicht	Kg	55	
Voltaggio standard • Voltage standard • Standard voltage Voltaje • Anschlußspannung		V230/50Hz/1	

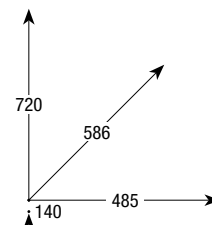

<b>KF 145</b>		A	W
Produzione • Production • Production Produccion • Tagesleistung	*Kg/24h Lb/24h	135 297	141 310
Capacità contenitore • Capacité bac • Bin capacity Capacidad del deposito • Behälterkapazität	Kg - Lb	42 - 92	
Assorbimento • Consommation • Power Potencia • Leistungsaufnahme	(T=43°C)-W	590	
Peso netto • Poids net • Net weight Peso neto • Nettogewicht	Kg	69	
Voltaggio standard • Voltage standard • Standard voltage Voltaje • Anschlußspannung		V230/50Hz/1	

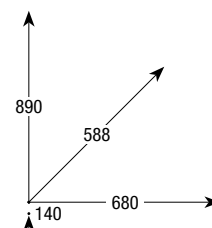

<b>KF 185</b>		A	W
Produzione • Production • Production Produccion • Tagesleistung	*Kg/24h Lb/24h	175 385	183 403
Capacità contenitore • Capacité bac • Bin capacity Capacidad del deposito • Behälterkapazität	Kg - Lb	60 - 132	
Assorbimento • Consommation • Power Potencia • Leistungsaufnahme	(T=43°C)-W	650	
Peso netto • Poids net • Net weight Peso neto • Nettogewicht	Kg	85	
Voltaggio standard • Voltage standard • Standard voltage Voltaje • Anschlußspannung		V230/50Hz/1	

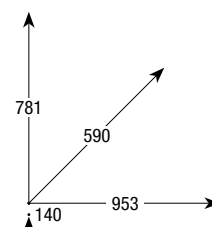

<b>KF 200</b>		A	W
Produzione • Production • Production Produccion • Tagesleistung	*Kg/24h Lb/24h	195 429	205 451
Contenitore • Bac • Bin • Deposito • Behälter		TF 60/RB 60 B/BF 100 • B/BF 150 B/BF 250	
Assorbimento • Consommation • Power Potencia • Leistungsaufnahme	(T=43°C)-W	800	
Peso netto • Poids net • Net weight Peso neto • Nettogewicht	Kg	58	
Voltaggio standard • Voltage standard • Standard voltage Voltaje • Anschlußspannung		V230/50Hz/1	

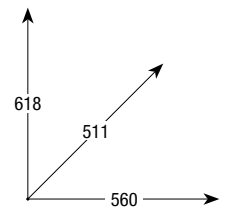

<b>KF 300</b>		A	W
Produzione • Production • Production Produccion • Tagesleistung	*Kg/24h Lb/24h	300 660	305 671
Contenitore • Bac • Bin • Deposito • Behälter		TF 60/RB 60 B/BF 100 • B/BF 150 B/BF 250	
Assorbimento • Consommation • Power Potencia • Leistungsaufnahme	(T=43°C)-W	1150	
Peso netto • Poids net • Net weight Peso neto • Nettogewicht	Kg	58	
Voltaggio standard • Voltage standard • Standard voltage Voltaje • Anschlußspannung		V230/50Hz/1	

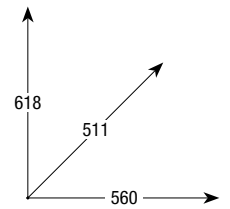

<b>KF 600</b>		A	W
Produzione • Production • Production Produccion • Tagesleistung	*Kg/24h Lb/24h	600 1320	615 1353
Contenitore • Bac • Bin • Deposito • Behälter		B/BF 150 • B/BE/BF 150 B/BF 250 • B/BE/BF 250	
Assorbimento • Consommation • Power Potencia • Leistungsaufnahme	(T=43°C)-W	1950	
Peso netto • Poids net • Net weight Peso neto • Nettogewicht	Kg	111	
Voltaggio standard • Voltage standard • Standard voltage Voltaje • Anschlußspannung		V230/50Hz/1	

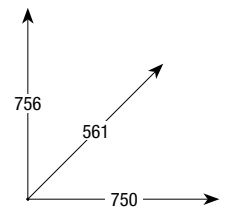

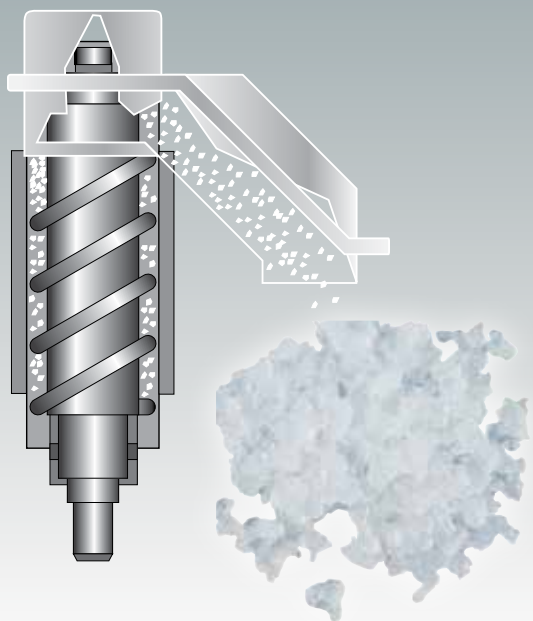

<b>KF 1200</b>		A	W
Produzione • Production • Production Produccion • Tagesleistung	*Kg/24h Lb/24h	1150 2530	1165 2563
Contenitore • Bac • Bin • Deposito • Behälter		B/BF 250 B/BE/BF 250	
Assorbimento • Consommation • Power Potencia • Leistungsaufnahme	(T=43°C)-W	3600	
Peso netto • Poids net • Net weight Peso neto • Nettogewicht	Kg	173	
Voltaggio standard • Voltage standard • Standard voltage Voltaje • Anschlußspannung		V400/50Hz/3	

<b>KF 2500</b>		A	W
Produzione • Production • Production Produccion • Tagesleistung	*Kg/24h Lb/24h	2300 5060	2330 5126
Contenitore • Bac • Bin • Deposito • Behälter		-	
Assorbimento • Consommation • Power Potencia • Leistungsaufnahme	(T=43°C)-W	2x3600	
Peso netto • Poids net • Net weight Peso neto • Nettogewicht	Kg	295	
Voltaggio standard • Voltage standard • Standard voltage Voltaje • Anschlußspannung		V400/50Hz/3	

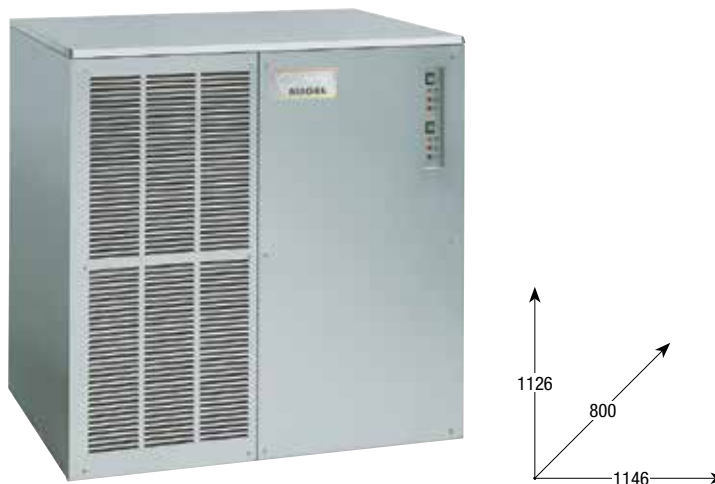



**SERIE** **KFP**



**Fabbricatori di ghiaccio granulare serie KFP**

Il ghiaccio granulare pressato della serie KFP è ideale per l'uso nei bar, laboratori, ospedali, panifici, macellerie, pescherie, fast food e ristoranti.

**Machines à glace en grains série KFP**

La glace en grains pressée serie KFP est idéale pour bar, laboratoires, hôpitaux, boulangeries, boucheries, poissonneries, Fast Food et restaurants.

**Ice flake machines series KFP**

The pressed ice flake of series KFP is ideal for bar, laboratories, hospitals, bakeries, butchers, fishmongers, Fast Food outlets and restaurants.

**Fabricadores de hielo granular serie KFP**

El hielo granular prensado ideal para bar, laboratorios, hospitales, panificadores, carnicerías, pescaderías, Fast Food y restaurantes.

**Eisflockenbereiter Serie KFP**

Die gepresste Eisflocke der Serie KFP ist ideal für den Gebrauch in Bar, Laboratorien, Krankenhäusern, Bäckereien, Fleischereien, Fischhandel, Fast Food und Restaurants.

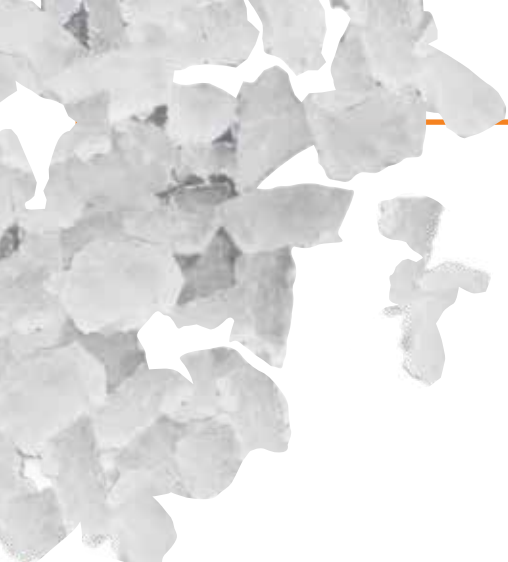

<b>KFP 85</b>		A	W
Produzione • Production • Production Produccion • Tagesleistung	*Kg/24h Lb/24h	75 165	78 172
Capacità contenitore • Capacité bac • Bin capacity Capacidad del deposito • Behälterkapazität	Kg - Lb	25 - 55	
Assorbimento • Consommation • Power Potencia • Leistungsaufnahme	(T=43°C)-W	520	
Peso netto • Poids net • Net weight Peso neto • Nettogewicht	Kg	57	
Voltaggio standard • Voltage standard • Standard voltage Voltaje • Anschlußspannung		V230/50Hz/1	

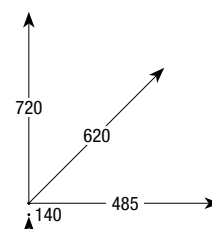

<b>KFP 145</b>		A	W
Produzione • Production • Production Produccion • Tagesleistung	*Kg/24h Lb/24h	120 264	125 275
Capacità contenitore • Capacité bac • Bin capacity Capacidad del deposito • Behälterkapazität	Kg - Lb	42 - 92	
Assorbimento • Consommation • Power Potencia • Leistungsaufnahme	(T=43°C)-W	590	
Peso netto • Poids net • Net weight Peso neto • Nettogewicht	Kg	71	
Voltaggio standard • Voltage standard • Standard voltage Voltaje • Anschlußspannung		V230/50Hz/1	

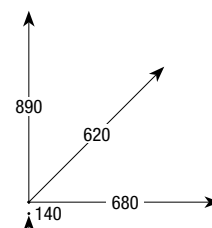

<b>KFP 185</b>		A	W
Produzione • Production • Production Produccion • Tagesleistung	*Kg/24h Lb/24h	165 363	170 374
Capacità contenitore • Capacité bac • Bin capacity Capacidad del deposito • Behälterkapazität	Kg - Lb	60 - 132	
Assorbimento • Consommation • Power Potencia • Leistungsaufnahme	(T=43°C)-W	650	
Peso netto • Poids net • Net weight Peso neto • Nettogewicht	Kg	85	
Voltaggio standard • Voltage standard • Standard voltage Voltaje • Anschlußspannung		V230/50Hz/1	

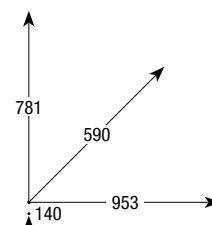

<b>KFP 200</b>		A	W
Produzione • Production • Production Produccion • Tagesleistung	*Kg/24h Lb/24h	175 385	180 396
Contenitore • Bac • Bin • Deposito • Behälter		TF 60/RB 60 B/BF 100 • B/BF 150 B/BF 250	
Assorbimento • Consommation • Power Potencia • Leistungsaufnahme	(T=43°C)-W	800	
Peso netto • Poids net • Net weight Peso neto • Nettogewicht	Kg	58	
Voltaggio standard • Voltage standard • Standard voltage Voltaje • Anschlußspannung		V230/50Hz/1	

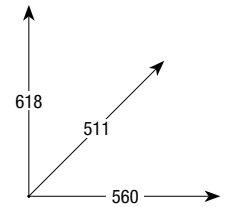

<b>KFP 300</b>		A	W
Produzione • Production • Production Produccion • Tagesleistung	*Kg/24h Lb/24h	270 594	275 605
Contenitore • Bac • Bin • Deposito • Behälter		TF 60/RB 60 B/BF 100 • B/BF 150 B/BF 250	
Assorbimento • Consommation • Power Potencia • Leistungsaufnahme	(T=43°C)-W	1150	
Peso netto • Poids net • Net weight Peso neto • Nettogewicht	Kg	58	
Voltaggio standard • Voltage standard • Standard voltage Voltaje • Anschlußspannung		V230/50Hz/1	

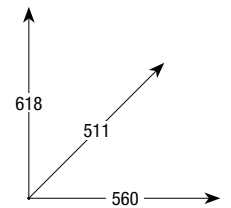

<b>KFP 600</b>		A	W
Produzione • Production • Production Produccion • Tagesleistung	*Kg/24h Lb/24h	500 1100	510 1120
Contenitore • Bac • Bin • Deposito • Behälter		B/BF 150 • B/BE/BF 150 B/BF 250 • B/BE/BF 250	
Assorbimento • Consommation • Power Potencia • Leistungsaufnahme	(T=43°C)-W	1950	
Peso netto • Poids net • Net weight Peso neto • Nettogewicht	Kg	111	
Voltaggio standard • Voltage standard • Standard voltage Voltaje • Anschlußspannung		V230/50Hz/1	

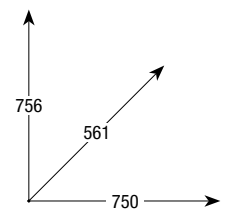



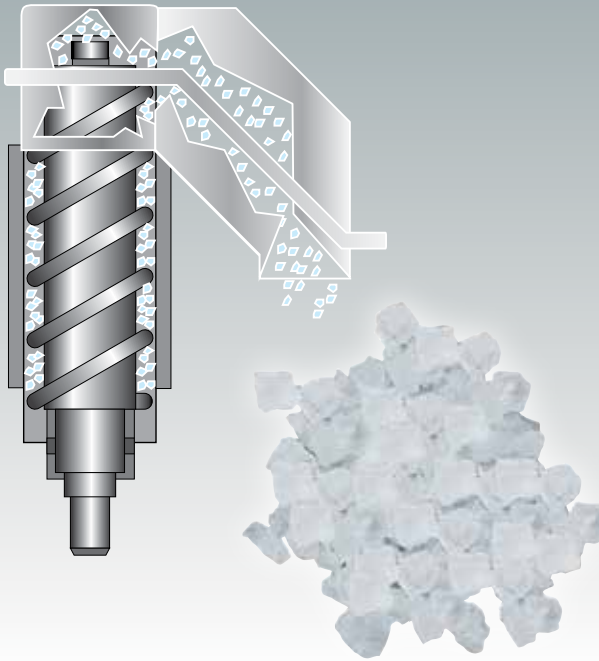

<b>KFP 1200</b>		A	W
Produzione • Production • Production Produccion • Tagesleistung	*Kg/24h Lb/24h	970 2134	980 2156
Contenitore • Bac • Bin • Deposito • Behälter		B/BF 250 B/BE/BF 250	
Assorbimento • Consommation • Power Potencia • Leistungsaufnahme	(T=43°C)-W	3600	
Peso netto • Poids net • Net weight Peso neto • Nettogewicht	Kg	173	
Voltaggio standard • Voltage standard • Standard voltage Voltaje • Anschlußspannung		V400/50Hz/3	

<b>KFP 2500</b>		A	W
Produzione • Production • Production Produccion • Tagesleistung	*Kg/24h Lb/24h	1700 3740	1720 3870
Contenitore • Bac • Bin • Deposito • Behälter		-	
Assorbimento • Consommation • Power Potencia • Leistungsaufnahme	(T=43°C)-W	2x3600	
Peso netto • Poids net • Net weight Peso neto • Nettogewicht	Kg	295	
Voltaggio standard • Voltage standard • Standard voltage Voltaje • Anschlußspannung		V400/50Hz/3	



# Contenitori & Accessori

## KL

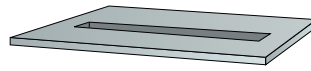

**BL 150**

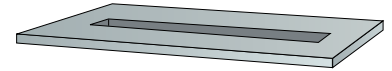
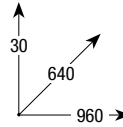

**BL 250**

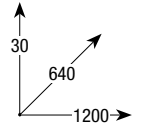

## KV

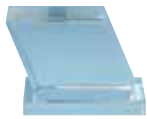

**BV 100**

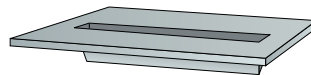
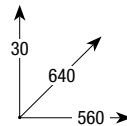

**BV 150**

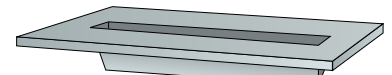
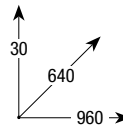

**BV 250**

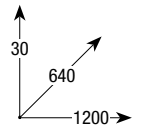

## KF/KFP



**BF 100**

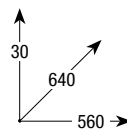

**BF 150**

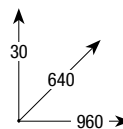

**BF 250**

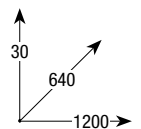

## KL/KV/KF/KFP

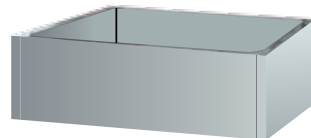

**BE 150**

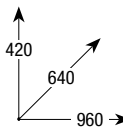

**BE 250**

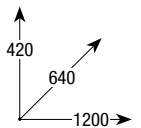

## KL/KV/KF/KFP



**B 100**

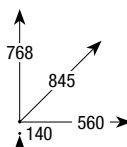

**B 150**

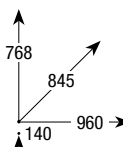

**B 250**

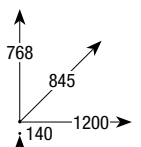



**Attenzione:**

Le produzioni nelle 24h si intendono ad una temperatura ambiente +10°C e una temperatura acqua +10°C. Il voltaggio standard è V230/50Hz monofase. Altri voltaggi come V230/60Hz e V115/60Hz monofase a richiesta. I modelli e le caratteristiche possono subire modifiche senza preavviso.

**Attention:**

Les productions dans les 24 heures s'entendent à une température ambiante de + 10°C et à une température de l'eau de +10°C. Le voltage standard est de 230V/50Hz monophasé. Sur demande, possibilité de fourniture d'autres voltages comme le 230V/50Hz et le 115V/60Hz monophasé. Les modèles et les caractéristiques peuvent subir des modifications sans préavis.

**Important:**

24h production is intended at an ambient temperature of +10°C with a water temperature of +10°C. Standard voltage is V230/50Hz single phase. Other voltages such as V230/60Hz and V115/60Hz single phase on request. Models and specifications may be subject to variations without prior notice.

**Atención:**

Las producciones en las 24h se consideran con una temperatura ambiente de +10°C y una temperatura del agua de +10°C. El voltaje estándar es V230/50HZ monofásico. Otros voltajes como V230/60HZ y V115/60HZ monofásico a petición. Los modelos y las características pueden sufrir variaciones sin aviso previo.

**Achtung:**

Die Produktion innerhalb von 24 Stunden versteht sich bei einer Raumtemperatur von +10°C sowie einer Wassertemperatur von +10°C. Die Standardspannung beträgt V230/50HZ einphasig. Weitere Spannungswerte wie V230/60HZ und V115/60 HZ einphasig auf Anfrage. Die Modelle und Charakteristiken können Änderungen ohne Vorankündigung unterliegen.



**ice line**

**MIGEL**

**Migel S.r.l.**

Viale Risorgimento, 28 - I - 20030 Senago (MI)

Tel. (+39) 02 99057727 - Fax (+39) 02 99056470

<http://www.migel-ice-line.com> - e-mail: [migel@migel-ice-line.com](mailto:migel@migel-ice-line.com)

RAEE N°IT08020000001142

