

LISTINO PREZZI



**FABBRICATORI DI GHIACCIO
in cubetti pieni**

KL-KD



**FABBRICATORI DI GHIACCIO
in cubetti cavi**

KP



**FABBRICATORI DI GHIACCIO
in cubetti a lastra**

KVB-KV



**FABBRICATORI DI GHIACCIO
granulare**

KF



**FABBRICATORI DI GHIACCIO
granulare pressato**

KFP



**CONTENITORI DI GHIACCIO
E ACCESSORI**

BL/BV/BF/B/BE

2021/2



Certificato

SQS attesta che l'azienda sotto indicata dispone di un sistema di management che soddisfa le esigenze della normativa indicata.



Migel S.r.l.
Viale Risorgimento, 28
20030 Senago (MI)
Italia

Campo d'applicazione

Sito di Viale Risorgimento, 28
20030 Senago (MI) / Italia

Ambito d'attività

Ricerca, sviluppo e produzione di fabbricatori di ghiaccio

Base normativa

ISO 9001:2015

Sistema di gestione per la qualità

Scope(s) 18

Validità 11.05.2019 – 10.05.2022
Emissione 11.05.2019

No. di reg. 24220

4000_4/Febrero 2019/Versione 1.1



sqs.ch



X. Edelmann
X. Edelmann, Presidente SQS

F. Müller
F. Müller, CEO SQS

Associazione Svizzera per Sistemi di Qualità e di Management SQS
Bernstrasse 103, 3052 Zollikofen, Svizzera



Swiss Made





ice line

MIGEL



KL-KD



KP

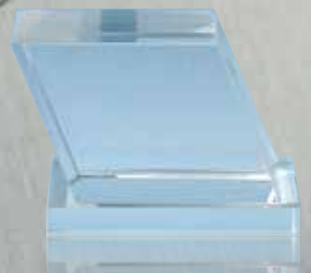

KVB-KV



KFP



KF

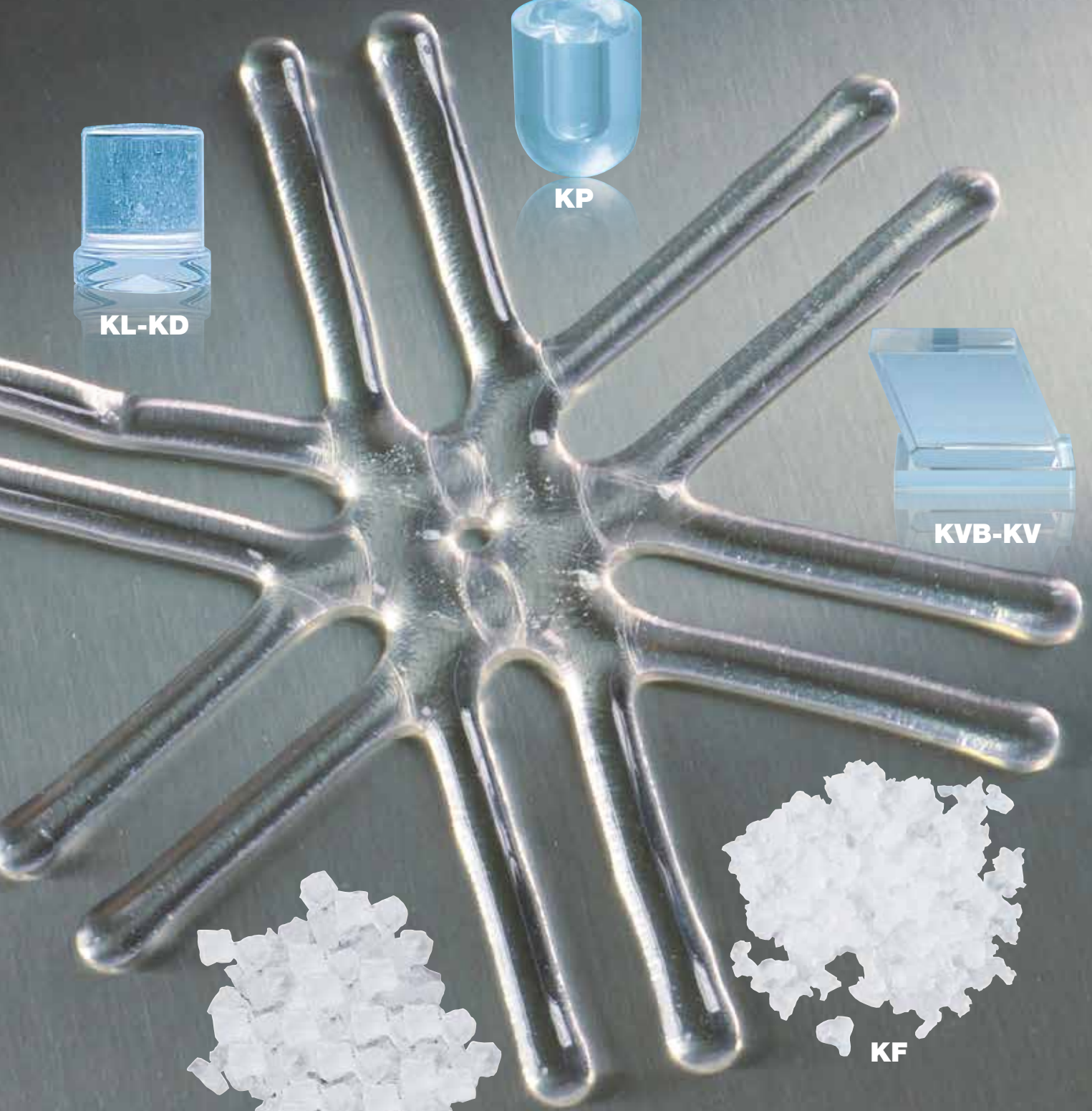

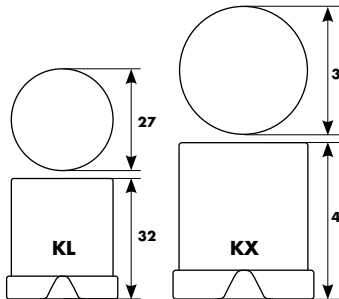
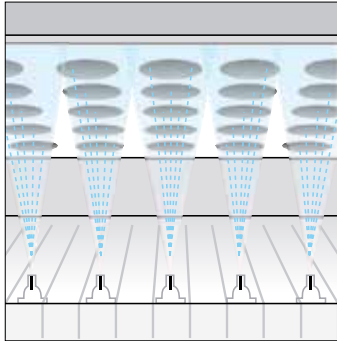

FILTRO
a richiesta



POMPA MIGEL











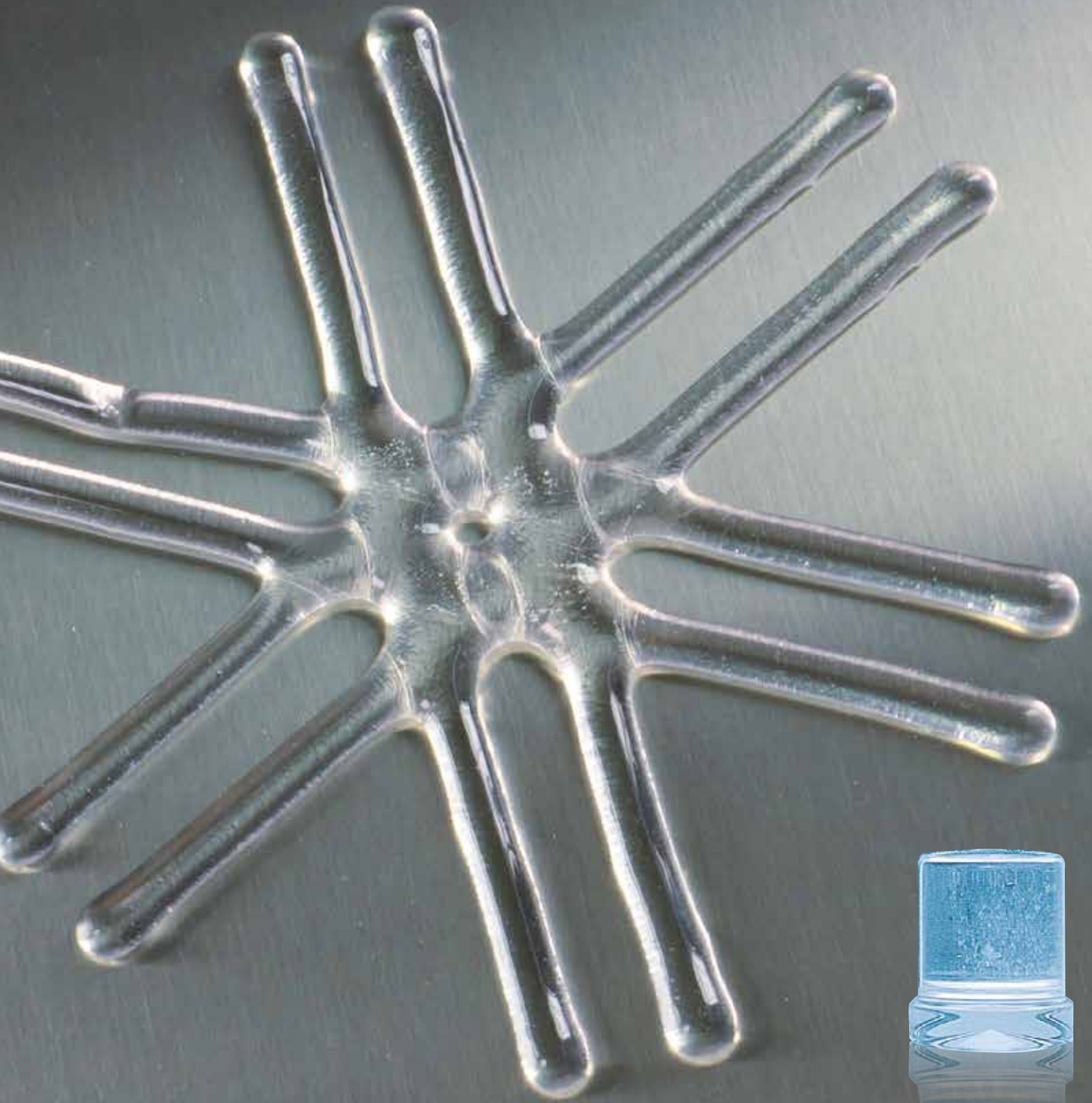



KL 32F - KL 42F - KL 52F





SPRUZZATORE MIGEL

SERIE KL-KD

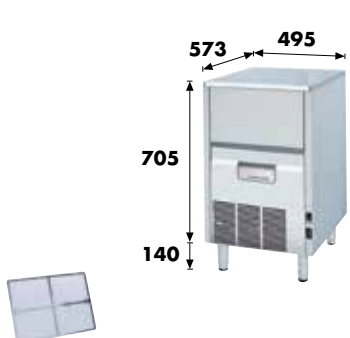
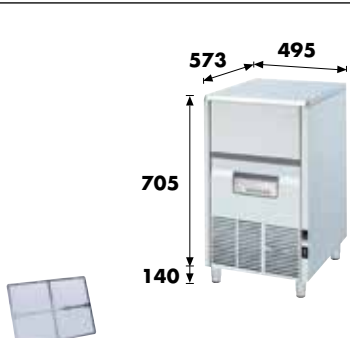
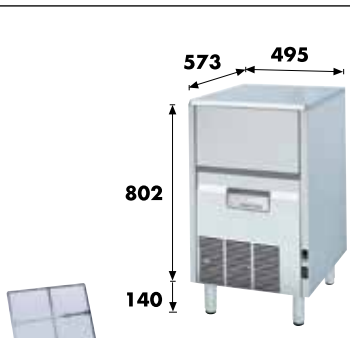

MODELLO	DIMENSIONI LxPxH (mm)	Kg/24H FINO A	CONTE- NITORE Kg	PREZZO AL PUBBLICO EURO (IVA ESCLUSA)	IMBALLO M ³ - Kg (LxPxH)
SERIE KL FABBRICATORI DI GHIACCIO in cubetti pieni Carrozzeria acciaio inox AISI 304 - Voltaggio V230/Hz50/monofase 					
KL 18 3L0018A 3L0018W	  Carrozzeria acciaio plastificato	21 22	6,5	1.073,00	0,17 - 34 (440x530x720)
FILTRO 1CD182				13,20	
KL 20 3L0020A 3L0020W	  Carrozzeria acciaio inox	21 22	6,5	1.129,00	0,17 - 34 (440x530x720)
FILTRO 1CD182				13,20	
KL 22 3L0021A 3L0021W	  Carrozzeria acciaio inox	24 25	6,5	1.230,00	0,17 - 34 (440x530x720)
FILTRO 1CD182				13,20	
KL 32 3L0031A 3L0031W	  Carrozzeria acciaio inox	30 31	11	1.483,00	0,22 - 42 (460x600x790)
FILTRO 1CD154				13,20	
KL 32F da incasso 3L0031F	  Carrozzeria acciaio inox	30	11	1.539,00	0,22 - 42 (460x600x790)
FILTRO 1CD155				13,20	

I modelli e le caratteristiche possono subire modifiche senza preavviso.







MODELLO	DIMENSIONI LxPxH (mm)	Kg/24H FINO A	CONTE- NITORE Kg	PREZZO AL PUBBLICO EURO (IVA ESCLUSA)	IMBALLO M ³ - Kg (LxPxH)
SERIE KL FABBRICATORI DI GHIACCIO in cubetti pieni Carrozzeria acciaio inox AISI 304 - Voltaggio V230/Hz50/monofase 					
KL 42 3L0041A 3L0041W FILTRO 1CD154		40 42	17	1.712,00 13,20	0,31 - 50 (550x660x860)
KL 42F da incasso 3L0041F FILTRO 1CD155		40	17	1.778,00 13,20	0,31 - 50 (550x660x860)
KL 52 3L0051A 3L0051W FILTRO 1CD154		50 52	20	1.869,00 13,20	0,34 - 53 (550x660x940)
KL 52F da incasso 3L0051F FILTRO 1CD155		50	20	1.940,00 13,20	0,34 - 53 (550x660x940)
KL 62 3L0061A 3L0061W FILTRO 1CD156		60 62	20	2.030,00 18,20	0,36 - 57 (550x660x1000)

■ Optional

A= Raffreddamento ad aria **F**= Raffreddamento ad aria per l'incasso **W**= Raffreddamento ad acqua

MODELLO	DIMENSIONI LxPxH (mm)	Kg/24H FINO A	CONTE- NITORE Kg	PREZZO AL PUBBLICO EURO (IVA ESCLUSA)	IMBALLO M³ - Kg (LxPxH)
SERIE KL FABBRICATORI DI GHIACCIO in cubetti pieni Carrozzeria acciaio inox AISI 304 - Voltaggio V230/Hz50/monofase					
KL 72 3L0071A 3L0071W FILTRO 1CD156		70 72	30	2.350,00 18,20	 0,52 - 70 (730x680x1050)
KL 102 3L0102A 3L0102W FILTRO 1CD156		88 90	45	2.653,00 18,20	0,55 - 77 (730x680x1110)
KL 132 3L0132A 3L0132W FILTRO 2CD156		125 127	65	3.326,00 31,90	0,79 - 98 (1050x680x1110)
KL 152 3L0152A 3L0152W FILTRO 2CD156		145 147	65	3.600,00 31,90	0,83 - 109 (1050x680x1160)
KL 172 3L0172A 3L0172W		150 152	Vedi B/BL	3.428,00	0,53 - 88 (1040x730x700)

I modelli e le caratteristiche possono subire modifiche senza preavviso.

MODELLO	DIMENSIONI LxPxH (mm)	Kg/24H FINO A	CONTE- NITORE Kg	PREZZO AL PUBBLICO EURO (IVA ESCLUSA)	IMBALLO M³ - Kg (LxPxH)
SERIE KL FABBRICATORI DI GHIACCIO in cubetti pieni Carrozzeria acciaio inox AISI 304 - Voltaggio V230/Hz50/monofase					
KL 302 3L0302A 3L0302W		260 262	Vedi B/BL	5.612,00	 0,78 - 141 (1040x730x1030)
SERIE B/BL CONTENITORI DI GHIACCIO + PIANI D'APPOGGIO utilizzabili con i modelli serie KL 172, KL 302 Carrozzeria acciaio inox AISI 304					
B/BL 150 3BBL150		KL172 KL302	150	1.685,00	0,93 - 70 (1020x940x970)
B/BL 250 3BBL250		KL172 KL302	250	1.903,00	1,15 - 81 (1260x940x970)
SERIE B/BE/BL CONTENITORI DI GHIACCIO + ESTENSIONI + PIANI D'APPOGGIO utilizzabili con i modelli serie KL 172, KL 302 Carrozzeria acciaio inox AISI 304					
B/BE/BL 150 3BBEBL150		KL 172 KL 302	250	2.623,00	1,38 - 85 (1020x940x1440)
B/BE/BL 250 3BBEBL250		KL 302	400	3.136,00	1,70 - 105 (1260x940x1440)

■ Optional

A= Raffreddamento ad aria **F**= Raffreddamento ad aria per l'incasso **W**= Raffreddamento ad acqua

H
O
T
E
L
HOTEL

B
A
R

HOTEL

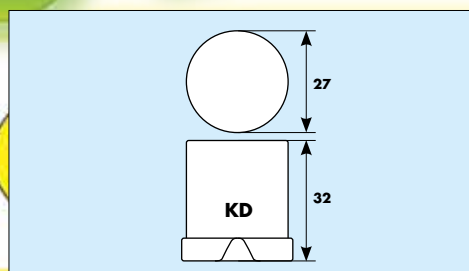





HOTEL

Caffè

Caffè

PUB

MODELLO	DIMENSIONI LxPxH (mm)	Kg/24H FINO A	CONTE- NITORE Kg	PREZZO AL PUBBLICO EURO (IVA ESCLUSA)	IMBALLO M ³ - Kg (LxPxH)
SERIE KD					
FABBRICATORI/DISTRIBUTORI DI GHIACCIO in cubetti pieni Carrozzeria acciaio inox AISI 304 - Voltaggio V230/Hz50/monofase					
KD 3 3KD003A 3KD003W		30 31	13	2.638,00	 0,29 - 63 (470x690x900)
KD 30 3KDT03A 3KDT03W		30 31	13	3.246,00	0,54 - 67 (470x690x1650)
3KDTW3A Con acqua fresca refrigerata incorporata 3KDTW3W				3.645,00	

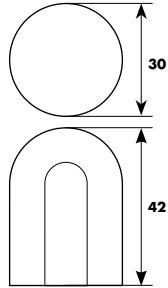
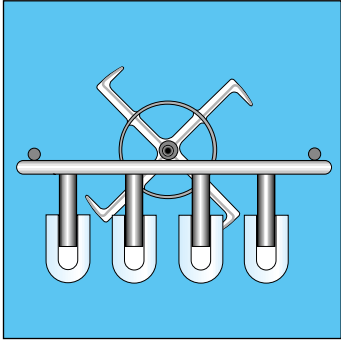

KP



FILTRO
a richiesta



KP 30F - KP 40F

SERIE KP

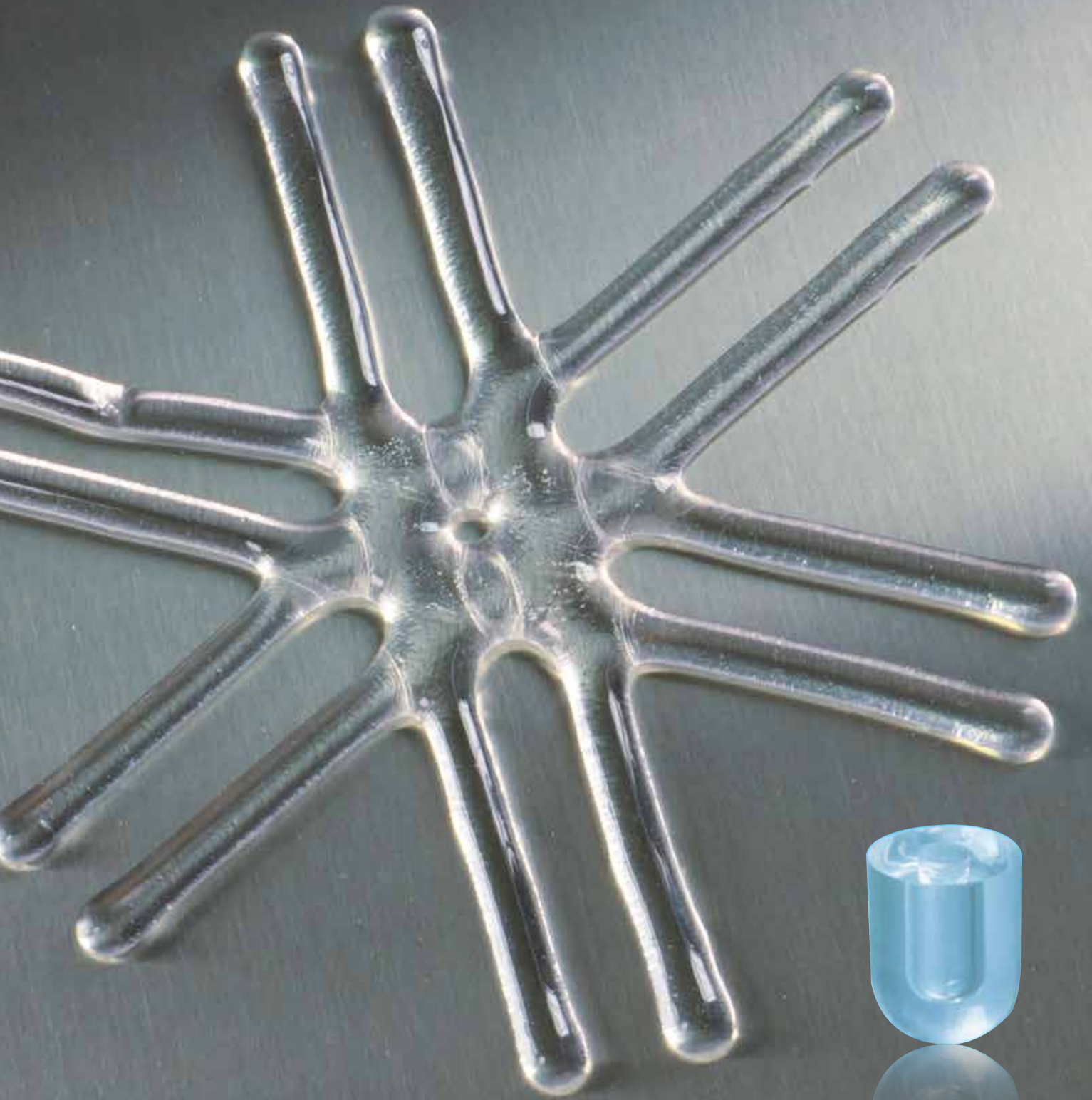

MODELLO	DIMENSIONI LxPxH (mm)	Kg/24H FINO A	CONTE- NITORE Kg	PREZZO AL PUBBLICO EURO (IVA ESCLUSA)	IMBALLO M ³ - Kg (LxPxH)
SERIE KP					
FABBRICATORI DI GHIACCIO in cubetti cavi Carrozzeria acciaio inox AISI 304 - Voltaggio V230/Hz50/monofase					
KP 20 3P0020A 3P0020W FILTRO 1CD154	 Carrozzeria acciaio inox	21 22	8	1.328,00 13,20	 0,22 - 42 (460x600x790)
KP 30 3P0030A 3P0030W FILTRO 1CD154		28 29	11	1.514,00 13,20	0,23 - 43 (460x600x840)
KP 30F da incasso 3P0030F FILTRO 1CD155		28	11	1.570,00 13,20	0,23 - 43 (460x600x840)
KP 40 3P0040A 3P0040W FILTRO 1CD154		37 39	13	1.747,00 13,20	0,24 - 44 (460x600x870)
KP 40F da incasso 3P0040F FILTRO 1CD155		37	13	1.814,00 13,20	0,24 - 44 (460x600x870)

I modelli e le caratteristiche possono subire modifiche senza preavviso.

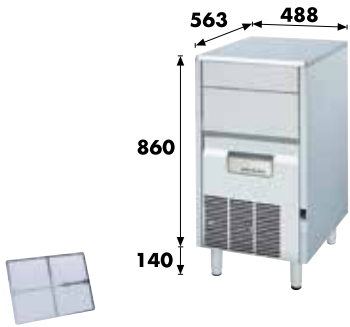
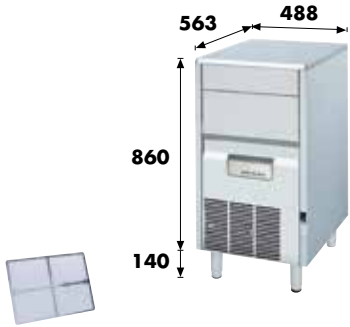
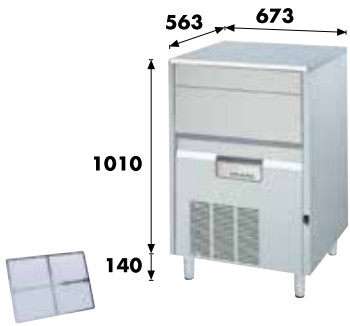
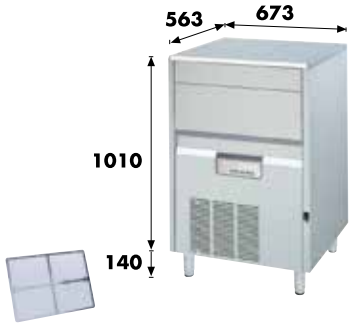
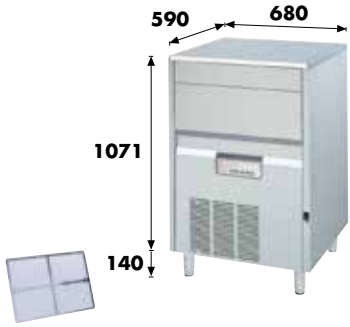
MODELLO	DIMENSIONI LxPxH (mm)	Kg/24H FINO A	CONTE- NITORE Kg	PREZZO AL PUBBLICO EURO (IVA ESCLUSA)	IMBALLO M ³ - Kg (LxPxH)
SERIE KP FABBRICATORI DI GHIACCIO in cubetti cavi Carrozzeria acciaio inox AISI 304 - Voltaggio V230/Hz50/monofase 					
KP 50 3P0050A 3P0050W FILTRO 1CD154		47 49	17	1.980,00 13,20	0,36 - 52 (550x650x1000)
KP 60 3P0060A 3P0060W FILTRO 1CD154		57 59	17	2.193,00 13,20	0,36 - 56 (550x650x1000)
KP 70 3P0070A 3P0070W FILTRO 1CD156		67 69	30	2.530,00 18,20	0,57 - 72 (730x660x1180)
KP 90 3P0090A 3P0090W FILTRO 1CD156		86 88	30	2.862,00 18,20	0,57 - 76 (730x660x1180)
KP 120 3P0120A 3P0120W FILTRO 1CD156		125 127	45	3.628,00 18,20	0,60 - 84 (730x660x1240)

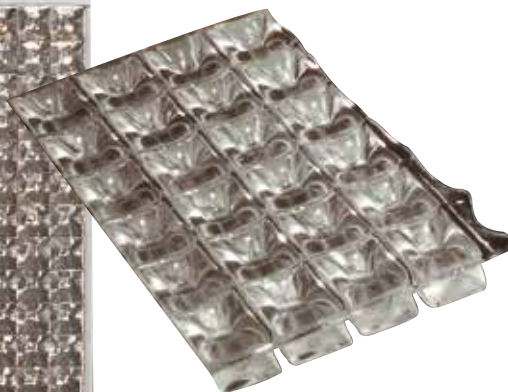
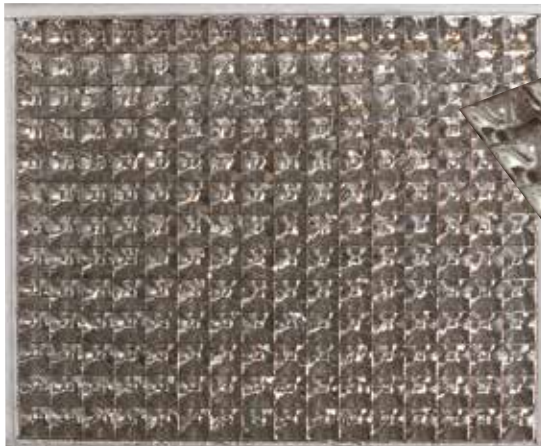
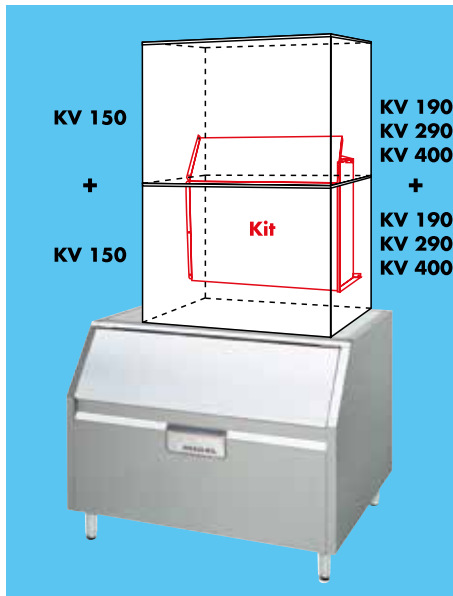
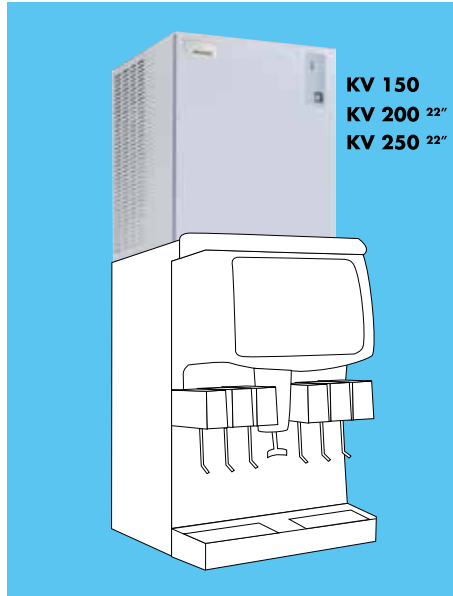
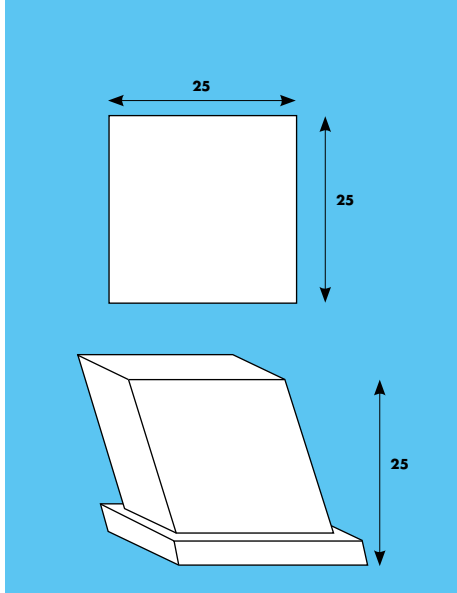

■ Optional

A= Raffreddamento ad aria **F**= Raffreddamento ad aria per l'incasso **W**= Raffreddamento ad acqua



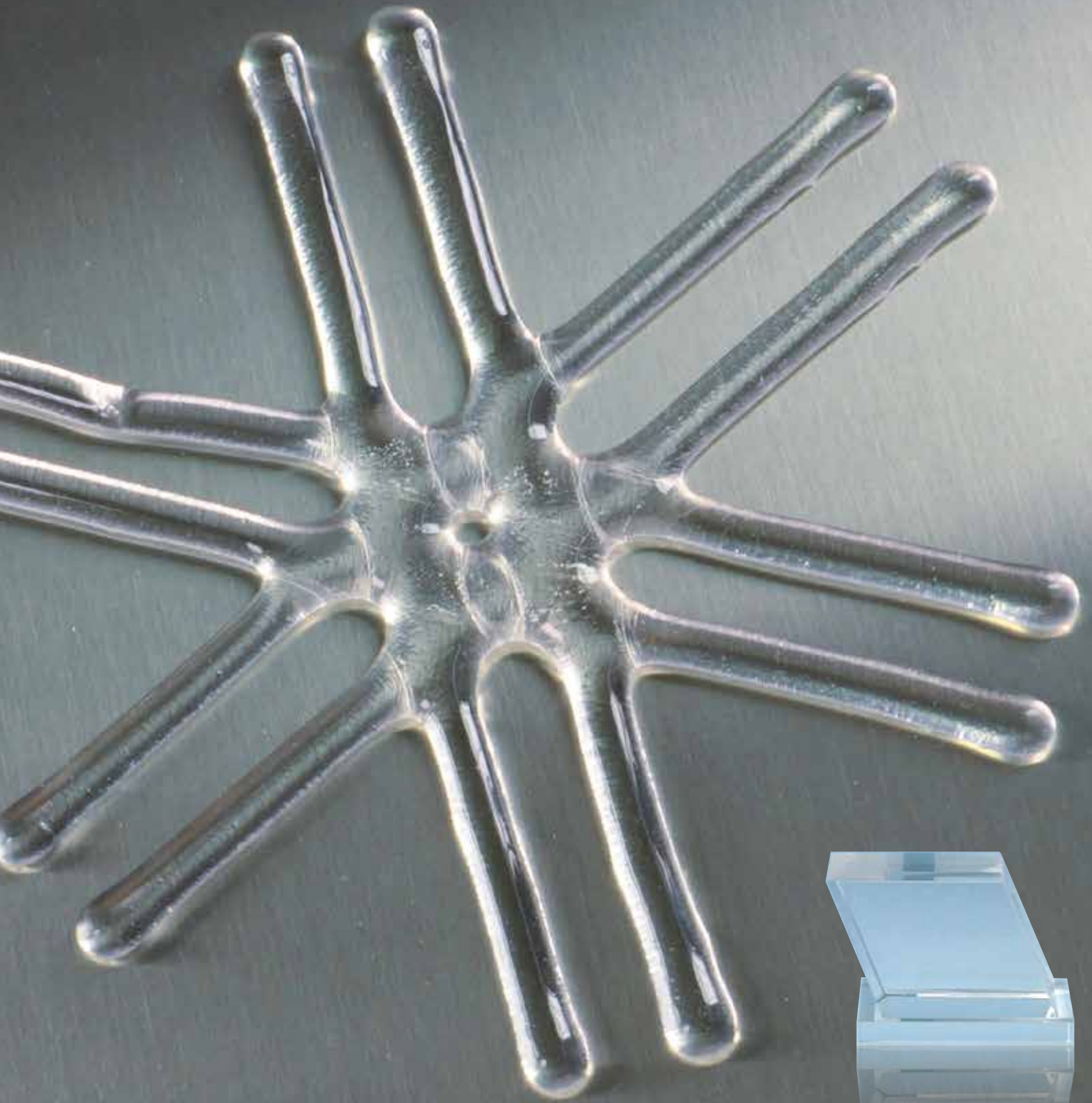





SERIE **KVB-KV**



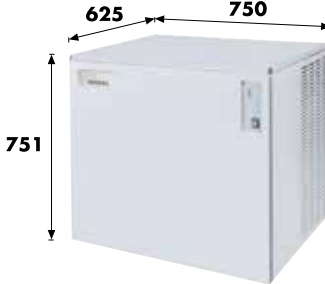

MODELLO	DIMENSIONI LxPxH (mm)	Kg/24H FINO A	CONTE- NITORE Kg	PREZZO AL PUBBLICO EURO (IVA ESCLUSA)	IMBALLO M ³ - Kg (LxPxH)
SERIE KV FABBRICATORI DI GHIACCIO in cubetti a lastra Carrozzeria acciaio inox AISI 304 - Voltaggio V230/Hz50/monofase 					
KVB 40 3VB040A 3VB040W FILTRO 1CD154		39 41	17	2.043,00 13,20	0,31 - 50 (550x660x860)
KVB 80 3VB080A 3VB080W FILTRO 1CD156		79 81	30	2.889,00 18,20	0,52 - 70 (730x680x1050)
KVB 120 3VB120A 3VB120W FILTRO 1CD156		125 127	45	3.517,00 18,20	0,55 - 74 (730x680x1100)
KV 150 3V0150A 3V0150W		140 145	vedi B/BV	3.071,00	0,34 - 62 (700x680x720)
KV 190 3V0190A 3V0190W		195 200	vedi B/BV	3.502,00	0,41 - 79 (830x680x720)

I modelli e le caratteristiche possono subire modifiche senza preavviso.

MODELLO	DIMENSIONI LxPxH (mm)	Kg/24H FINO A	CONTE- NITORE Kg	PREZZO AL PUBBLICO EURO (IVA ESCLUSA)	IMBALLO M ³ - Kg (LxPxH)
SERIE KV FABBRICATORI DI GHIACCIO in cubetti a lastra Carrozzeria acciaio inox AISI 304 - Voltaggio V230/Hz50/monofase 					
KV 290 3V0270A 3V0270W		290 295	vedi B/BV	3.911,00	0,41 - 86 (830x680x720)
KV 400 3V0400A 3V0400W		385 395	vedi B/BV	5.105,00	0,50 - 111 (830x680x890)
SERIE B/BV CONTENITORI DI GHIACCIO + PIANI D'APPOGGIO utilizzabili con i modelli serie KV 150, 190, 290, 400 Carrozzeria acciaio inox AISI 304					
B/BV 100 3BBV100		KV 150	100	1.333,00	0,55 - 44 (620x940x940)
B/BV 150 3BBV150		KV 190 KV 290 KV 400	150	1.640,00	0,93 - 70 (1020x940x970)
B/BV 250 3BBV250		KV 190 KV 290 KV 400	250	1.845,00	1,15 - 81 (1260x940x970)

■ Optional

A= Raffreddamento ad aria **F**= Raffreddamento ad aria per l'incasso **W**= Raffreddamento ad acqua

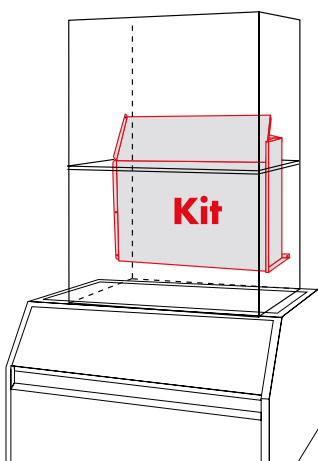
MODELLO	DIMENSIONI LxPxH (mm)	UTILIZZA- BILE CON	CONTE- NITORE Kg	PREZZO AL PUBBLICO EURO (IVA ESCLUSA)	IMBALLO M ³ - Kg (LxPxH)
SERIE B/BE/BV	CONTENITORI DI GHIACCIO + ESTENSIONI + PIANI D'APPOGGIO utilizzabili con i modelli serie KV 190, 290, 400 Carrozzeria acciaio inox AISI 304				
B/BE/BV 150 3BBEBV150		KV 190 KV 290 KV 400	250	2.578,00	1,38 - 85 (1020x940x1440)
B/BE/BV 250 3BBEBV250		KV 290 KV 400	400	3.078,00	1,70 - 105 (1260x940x1440)
KIT	ACCESSORIO SOVRAPPOSIZIONE DEI MODULARI SERIE KV Carrozzeria acciaio inox AISI 304				
KIT KV 3KIT02	 KV + KV	KV 150 KV 190 KV 290 KV 400	-	275,00	0,07 - 5 (670x600x170)



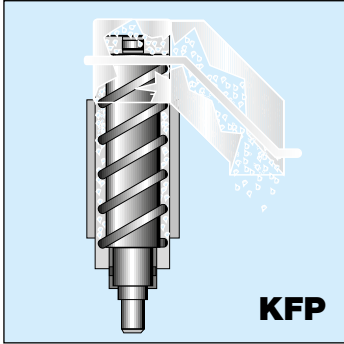
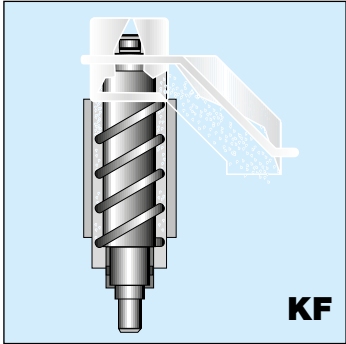

FILTRO
a richiesta



KF 85 - KFP 85

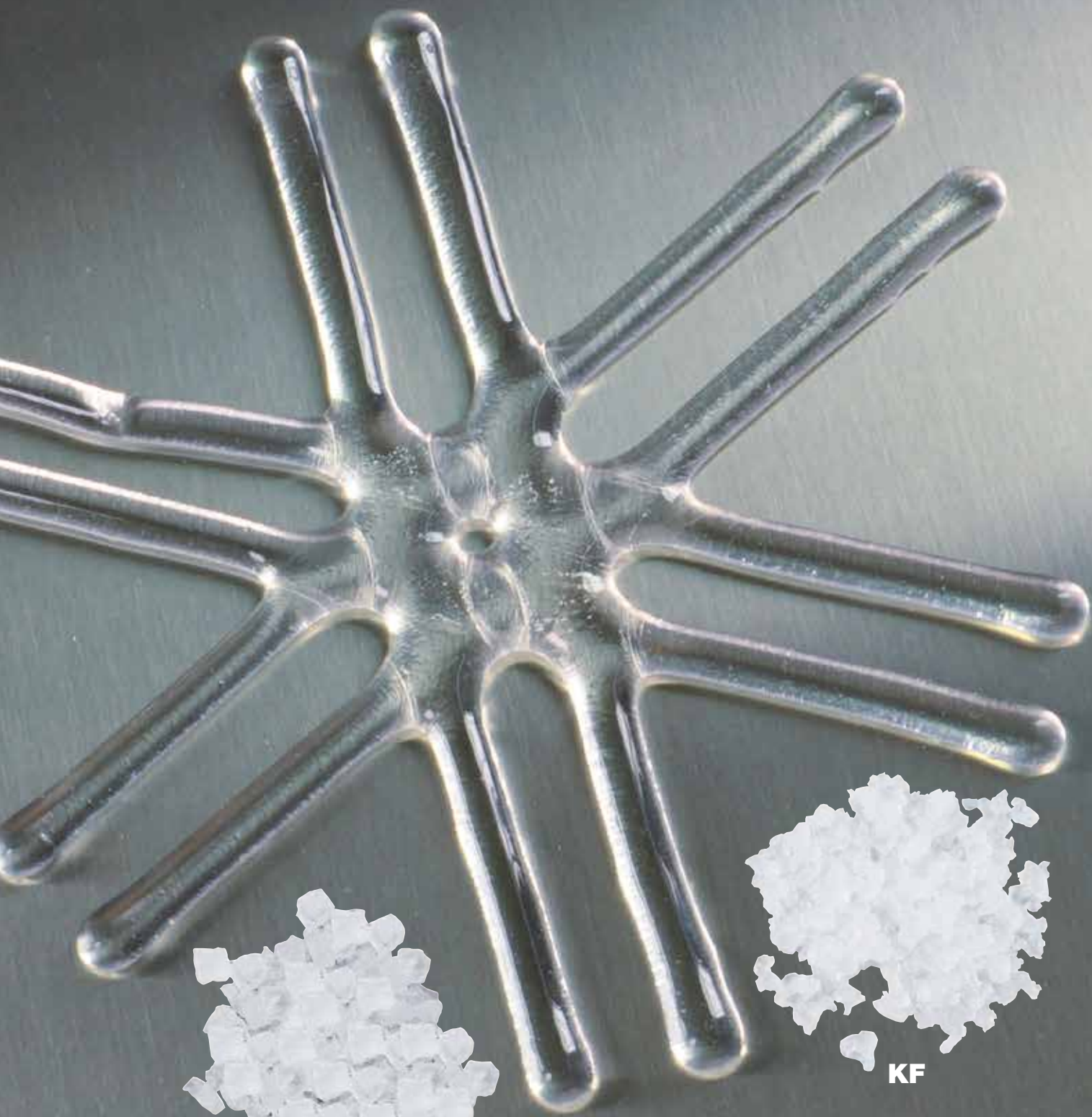

SERIE **KF - KFP**







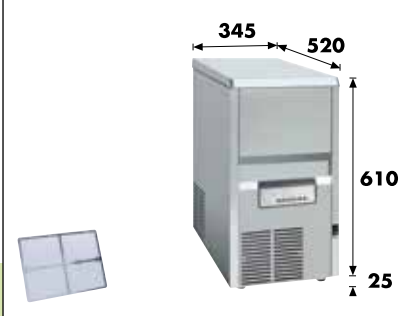

KFP



KF



MODELLO	DIMENSIONI LxPxH (mm)	Kg/24H FINO A	CONTE- NITORE Kg	PREZZO AL PUBBLICO EURO (IVA ESCLUSA)	IMBALLO M ³ - Kg (LxPxH)
SERIE KF FABBRICATORI DI GHIACCIO granulare Carrozzeria acciaio inox AISI 304 - Voltaggio V230/Hz50/monofase 					
KF 45 3F0035A 3F0035W FILTRO 1CD182		40 42	10	2.413,00 13,20	0,20 - 42 (440x600x760)
KF 85 3F0075A 3F0075W FILTRO 1CD155		80 83	25	2.900,00 13,20	0,31 - 56 (550x660x860)
KF 145 3F0125A 3F0125W FILTRO 1CD156		135 141	42	3.147,00 18,20	0,52 - 74 (730x680x1050)
KF 185 3F0165AMR 3F0165WMR FILTRO 1CD154		175 183	60	4.050,00 13,20	0,63 - 91 (1010x680x920)
KF 100 3F0100AMR 3F0100WMR		110 120	vedi B/BF	3.607,00	0,49 - 67 (810x790x770)

I modelli e le caratteristiche possono subire modifiche senza preavviso.



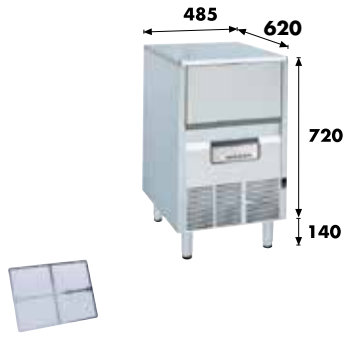
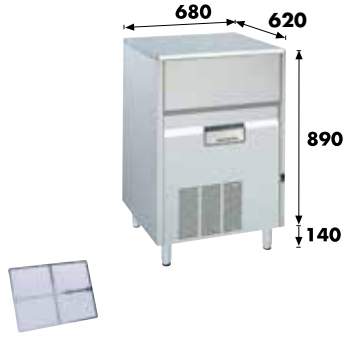

MODELLO	DIMENSIONI LxPxH (mm)	Kg/24H FINO A	CONTE- NITORE Kg	PREZZO AL PUBBLICO EURO (IVA ESCLUSA)	IMBALLO M³ - Kg (LxPxH)
SERIE KF FABBRICATORI DI GHIACCIO granulare Carrozzeria acciaio inox AISI 304 - Voltaggio V230/Hz50/monofase 					
KF 200 3F0180AMR 3F0180WMR		195 205	vedi B/BF	4.120,00	0,49 - 68 (810x790x770)
KF 300 3F0250AMR 3F0250WMR		300 305	vedi B/BF	4.670,00	0,49 - 75 (810x790x770)
KF 600 3F0500AMR 3F0500WMR		600 615	vedi B/BF	6.655,00	0,57 - 100 (810x790x890)
KF 1200 3F1000AMR 3F1000WMR	 <p>Voltaggio V400/Hz50/trifase</p>	1150 1165	vedi B/BF	9.973,00	0,90 - 161 (1050x790x1080)
KF 2500 3F2500AMR 3F2500WMR	 <p>Voltaggio V400/Hz50/trifase</p>	2300 2330	-	19.768,00	1,37 - 318 (1260x860x1260)

Macchine split/gruppi evaporatori a richiesta

A= Raffreddamento ad aria **F**= Raffreddamento ad aria per l'incasso **W**= Raffreddamento ad acqua

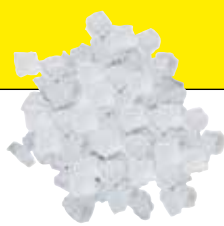
MODELLO	DIMENSIONI LxPxH (mm)	Kg/24H FINO A	CONTE- NITORE Kg	PREZZO AL PUBBLICO EURO (IVA ESCLUSA)	IMBALLO M³ - Kg (LxPxH)
SERIE KFP FABBRICATORI DI GHIACCIO granulare pressato Carrozzeria acciaio inox AISI 304 - Voltaggio V230/Hz50/monofase 					
KFP 85 3F0085A 3F0085W FILTRO 1CD155		75 78	25	3.295,00 13,20	0,31 - 56 (550x660x860)
KFP 145 3F0145A 3F0145W FILTRO 1CD156		120 125	42	3.577,00 18,20	0,52 - 74 (730x680x1050)
KFP 185 3F0185AMR 3F0185WMR FILTRO 1CD154		165 170	60	4.459,00 13,20	0,63 - 91 (1010x680x920)
KFP 200 3F0200AMR 3F0200WMR		175 180	vedi B/BF	4.337,00	0,49 - 68 (810x790x770)





I modelli e le caratteristiche possono subire modifiche senza preavviso.



MODELLO	DIMENSIONI LxPxH (mm)	Kg/24H FINO A	CONTE- NITORE Kg	PREZZO AL PUBBLICO EURO (IVA ESCLUSA)	IMBALLO M ³ - Kg (LxPxH)
SERIE KFP					
FABBRICATORI DI GHIACCIO granulare pressato Carrozzeria acciaio inox AISI 304 - Voltaggio V230/Hz50/monofase					
KFP 300 3F0300AMR 3F0300WMR		270 275	vedi B/BF	4.916,00	 0,49 - 75 (810x790x770)
KFP 600 3F0600AMR 3F0600WMR		500 510	vedi B/BF	7.006,00	0,57 - 100 (810x790x890)
KFP1200 3F1200AMR 3F1200WMR	 Voltaggio V400/Hz50/trifase	970 980	vedi B/BF	10.497,00	0,90 - 161 (1050x790x1080)
KFP 2500 3F1750AMR 3F1750WMR	 Voltaggio V400/Hz50/trifase	1700 1720	-	20.366,00	1,37 - 318 (1260x860x1260)

Macchine split/gruppi evaporatori a richiesta

A= Raffreddamento ad aria **F**= Raffreddamento ad aria per l'incasso **W**= Raffreddamento ad acqua

MODELLO	DIMENSIONI LxPxH (mm)	UTILIZZA- BILE CON	CONTE- NITORE Kg	PREZZO AL PUBBLICO EURO (IVA ESCLUSA)	IMBALLO M ³ - Kg (LxPxH)
---------	---------------------------------	--------------------------	----------------------------	--	---

SERIE B/BF	CONTENITORI DI GHIACCIO + PIANI D'APPOGGIO utilizzabili con i modelli serie KF - KFP Carrozzeria acciaio inox AISI 304				
B/BF 100 3BBF100		KF 100 KF 200 KF 300 KFP 200 KFP 300	100	1.352,00	0,55 - 44 (620x940x940)
B/BF 150 3BBF150		KF 200 KF 300 KF 600 KF 1200 KFP 200 KFP 300 KFP 600 KFP 1200	150	1.624,00	0,93 - 70 (1020x940x970)
B/BF 250 3BBF250		KF 300 KF 600 KF 1200 KFP 300 KFP 600 KFP 1200	250	1.822,00	1,15 - 81 (1260x940x970)
SERIE B/BE/BF	CONTENITORI DI GHIACCIO + ESTENSIONI + PIANI D'APPOGGIO utilizzabili con i modelli serie KF - KFP Carrozzeria acciaio inox AISI 304				
B/BE/BF 150 3BBEBF150		KF 300 KF 600 KF 1200 KFP 300 KFP 600 KFP 1200	250	2.563,00	1,38 - 85 (1020x940x1440)

MODELLO	DIMENSIONI LxPxH (mm)	UTILIZZA- BILE CON	CONTE- NITORE Kg	PREZZO AL PUBBLICO EURO (IVA ESCLUSA)	IMBALLO M ³ - Kg (LxPxH)
SERIE B/BE/BF	CONTENITORI DI GHIACCIO + ESTENSIONI + PIANI D'APPOGGIO utilizzabili con i modelli serie KF - KFP Carrozzeria acciaio inox AISI 304				
B/BE/BF 250 3BBEBF250		KF 600 KF 1200 KFP 600 KFP 1200	400	3.055,00	1,70 - 105 (1260x940x1440)
SERIE TF/RB	CONTENITORI A RUOTE + SUPPORTI FABBRICATORE utilizzabili con i modelli serie KF - KFP Carrozzeria acciaio inox AISI 304				
TF 60 3TF060		KF 100 KF 200 KF 300 KF 600	-	1.030,00	0,79 - 32 (1220x720x900)
RB 60 3RB060		KFP 200 KFP 300 KFP 600	60	1.284,00	0,47 - 39 (725x695x930)
TF 100 3TF100		KF 100 KF 200 KF 300 KF 600 KF 1200	-	1.165,00	0,79 - 33 (1220x720x900)
RB 100 3RB100		KFP 200 KFP 300 KFP 600 KFP 1200	100	1.597,00	0,57 - 42 (620x980x930)

Macchine split/gruppi evaporatori a richiesta

A= Raffreddamento ad aria **F**= Raffreddamento ad aria per l'incasso **W**= Raffreddamento ad acqua

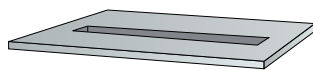

BL 150

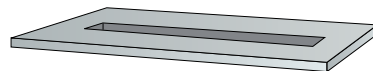

BL 250



BV 100

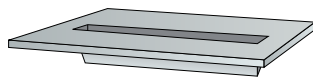

BV 150

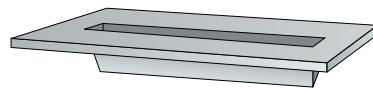

BV 250

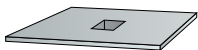

BF 100

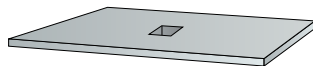

BF 150

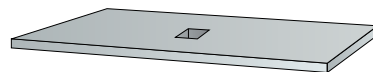

BF 250

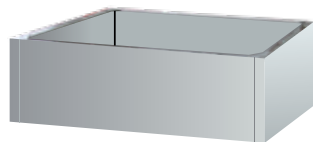

BE 150



BE 250



B 100



B 150



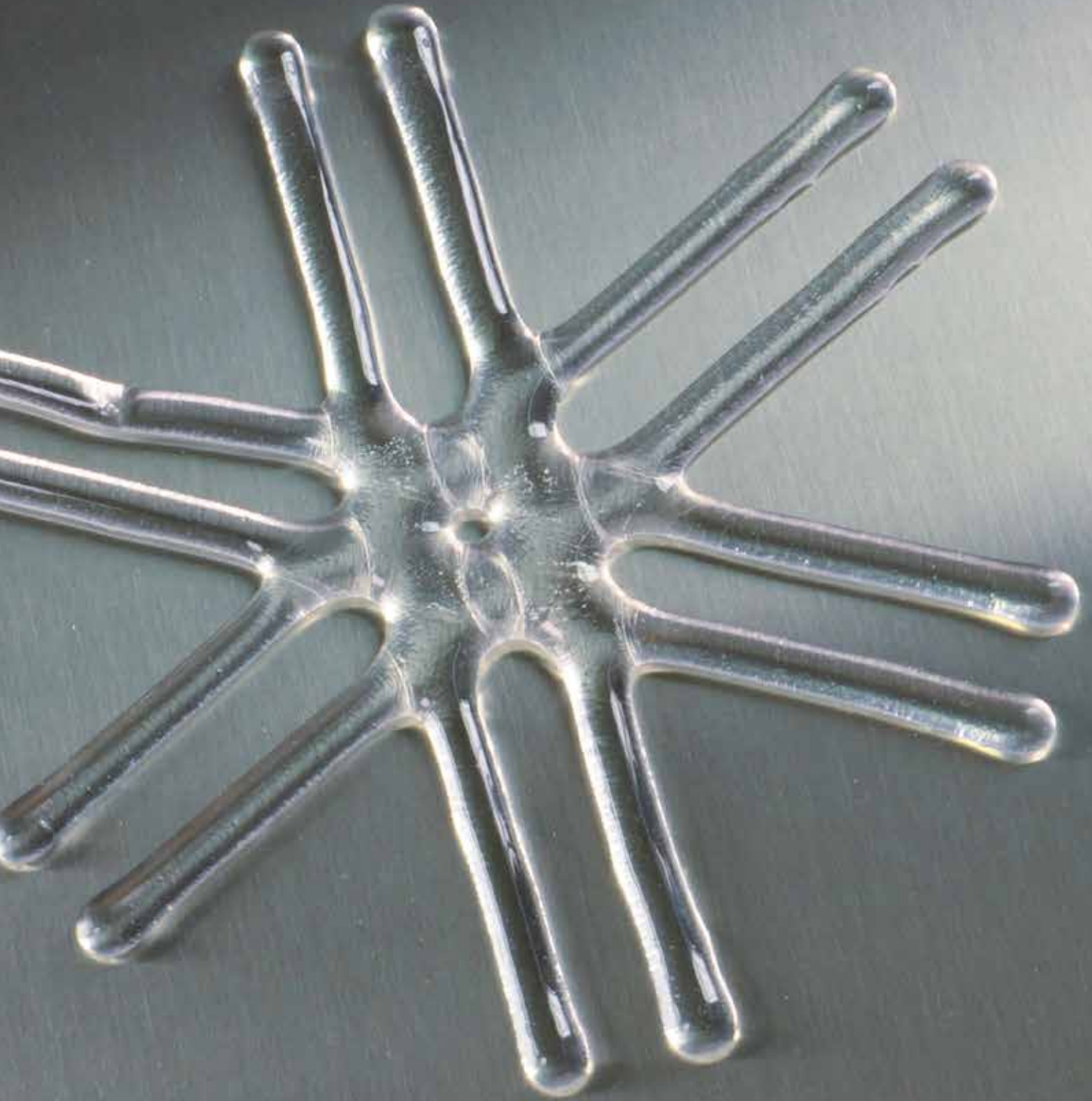

B 250

SERIE
CONTENITORI
&
ACCESSORI

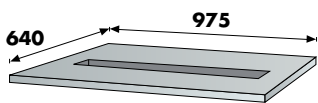
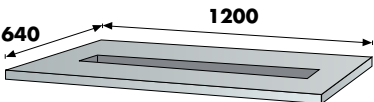
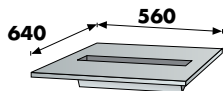
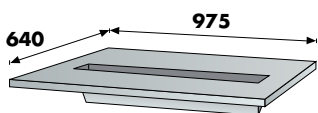
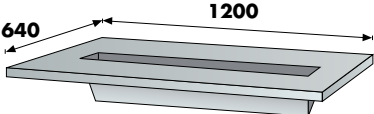
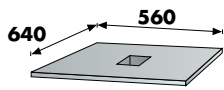
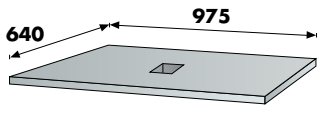
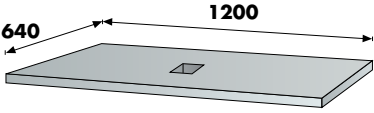

MODELLO	DIMENSIONI LxPxH (mm)	UTILIZZA- BILE CON	CONTE- NITORE	PREZZO AL PUBBLICO EURO (IVA ESCLUSA)	IMBALLO M ³ - Kg (LxPxH)
BL	PIANI D'APPOGGIO utilizzabili con i modelli serie KL Carrozzeria acciaio inox AISI 304				
BL 150 3BL150		KL 172 KL 302	B 150 B/BE 250	296,00	0,18 - 9 (1240x160x920)
BL 250 3BL250		KL 172 KL 302	B 250 B/BE 400	345,00	0,18 - 10 (1240x160x920)
BV	PIANI D'APPOGGIO utilizzabili con i modelli serie KV Carrozzeria acciaio inox AISI 304				
BV 100 3BV100		KV 150	B 100	132,00	0,09 - 5 (780x160x720)
BV 150 3BV150		KV 190 KV 290 KV 400	B 150 B/BE 250	250,00	0,18 - 9 (1240x160x920)
BV 250 3BV250		KV 190 KV 290 KV 400	B 250 B/BE 400	287,00	0,18 - 10 (1240x160x920)
BF	PIANI D'APPOGGIO utilizzabili con i modelli serie KF Carrozzeria acciaio inox AISI 304				
BF 100 3BF100		KF 200 KF 300	B 100	151,00	0,09 - 4 (780x160x720)
BF 150 3BF150		KF 200 KF 300 KF 600	B 150 B/BE 250	235,00	0,05 - 9 (1240x60x720)
BF 250 3BF250		KF 300 KF 600 KF 1200	B 250 B/BE 400	264,00	0,05 - 10 (1240x60x720)

I modelli e le caratteristiche possono subire modifiche senza preavviso.

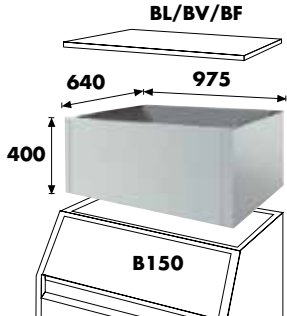
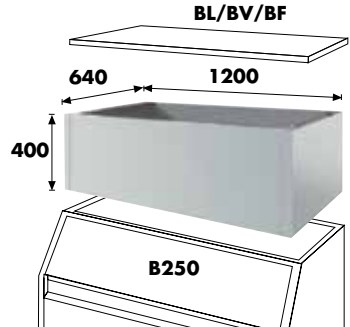
MODELLO	DIMENSIONI LxPxH (mm)	UTILIZZA- BILE CON	CONTE- NITORE Kg	PREZZO AL PUBBLICO EURO (IVA ESCLUSA)	IMBALLO M ³ - Kg (LxPxH)
B					
CONTENITORI DI GHIACCIO					
utilizzabili con i modelli serie KL - KV - KF -KFP				Carrozzeria acciaio inox AISI 304	
B 100 3B0100		KV KF KFP	100	1.201,00	0,53 - 37 (620x940x910)
B 150 3B0150		KL KV KF KFP	150	1.389,00	0,90 - 55 (1020x940x940)
B 250 3B0250		KL KV KF KFP	250	1.558,00	1,11 - 65 (1260x940x940)
BE					
ESTENSIONI CONTENITORI utilizzabili con serie B/BL - B/BV - B/BF 150/250					
utilizzabili con i modelli serie KL - KV - KF -KFP					
Carrozzeria acciaio inox AISI 304					
BE 150 3BE150		KL KV KF KFP	100	938,00	0,30 - 15 (1010x670x440)
BE 250 3BE250		KL KV KF KFP	150	1.232,00	0,36 - 24 (1230x670x440)



CONDIZIONI DI VENDITA

PREZZI	IVA esclusa
RESA	Franco ns. stabilimento Senago (MI)
IMBALLO	Standard - cartone su pallet - compreso nel prezzo. Imballi speciali verranno fatturati al costo.
GARANZIA	I fabbricatori di ghiaccio MIGEL sono coperti da garanzia per 12 mesi dalla data di installazione. La garanzia copre le parti difettose per errore di fabbricazione o per difetto di materiale. Le parti difettose dovranno essere rese franco ns. magazzino. La sostituzione delle parti riconosciute coperte da garanzia da parte MIGEL verranno sostituite gratuitamente franco ns. stabilimento. La MIGEL S.r.l. esclude ogni responsabilità per eventuali danni a persone o cose causati dalle proprie macchine da usi impropri, installazioni non conformi, cattiva manutenzione e/o mancato funzionamento temporaneo.
CONDIZIONI PREZZI	Potranno variare senza preavviso.
CARATTERISTICHE TECNICHE ED ESTETICHE	Soggette a variazioni senza preavviso.
TRASPORTO	La merce viaggia a rischio e pericolo dell'acquirente anche se resa franco destino.
RECLAMI	Eventuali reclami dovuti al trasporto dovranno essere rilevati immediatamente al vettore, annotati sui documenti di trasporto e fatti per iscritto entro 8 giorni dal ricevimento della merce.
VOLTAGGIO	Voltaggio standard: V 230/Hz 50/monofase, KF-P 1200/2500 V400/Hz 50/trifase, altri voltaggi V230-400/Hz 60 (codice 4...) e V115/Hz 60 (codice 5...) a richiesta con 4% sovrapprezzo.
RESE	Le produzioni indicate si intendono per installazioni ambiente 10°C e acqua 10°C.
RAEE	Gestione storici: I prezzi di listino applicati si intendono per prodotti destinati ad utenti che non necessitano di rendere il prodotto a fine vita in applicazione del D.Lgs. n. 151/2005 (RAEE). Qualsiasi ritiro di prodotto a causa di una vendita deve essere approvato da parte della MIGEL S.r.l.; gli oneri verranno sostenuti da MIGEL S.r.l. e dal rivenditore sulla base di separati accordi.
FORO	Ogni controversia legale è regolata dalla vigente legislazione italiana e rimanda al Foro di Milano.

I fabbricatori di ghiaccio della MIGEL S.r.l. sono marchiati CE, ciò garantisce la libera circolazione del prodotto all'interno della UE.

Installazione, collaudo e messa in servizio a carico del cliente



ice line

MIGEL

Migel S.r.l.

Viale Risorgimento, 28 - I - 20030 Senago (MI)

Tel. (+39) 02 99057727 - Fax (+39) 02 99056470

<http://www.migel-ice-line.com> - e-mail: migel@migel-ice-line.com

RAEE N°IT08020000001142

